

# MUSEO

CLICK, CORE,  
DIVIDUALS, DIWAN,  
ELLE, LAPSO,  
REMNANT, ROLL,  
TOTEM, VESTIGE.

**SANCAL** 



# El diseño no es ARTE pero puede ser artístico.

Parte de un proceso creativo y se inspira en multitud de campos. A veces, recupera influencias artísticas del pasado y las devuelve a la modernidad y, en otras ocasiones, es un faro de vanguardia para otras disciplinas.

La temática en la que se inspira la nueva colección hace un guiño al mundo del arte, pues presenta los productos como si de piezas de museo se tratara.

*“Nuestros muebles no son obras de arte, admiramos y respetamos demasiado a los artistas como para decir eso, pero nosotras los tratamos como si lo fueran”, admite Elena Castaño-López.*

Museo no es más que un ejercicio de reflexión sobre el trabajo creativo y pone de manifiesto la estrecha relación existente entre arte y diseño.

*“Tras años de experiencia trabajando con ilustradores y creativos, Elena y yo coincidimos en que la dedicación y pasión con la que diseñadores, interioristas y arquitectos emprenden cada nuevo proyecto es similar a la de cualquier artista. Y que se muestran igualmente vinculados al resultado de su trabajo”, aclara Esther Castaño-López.*

# Design is not ART but it can be artistic.

Design is a creative process that finds inspiration in many fields. Sometimes, artistic influences from the past are brought back to the modern world. Some others are at the vanguard of other disciplines.

The Museo collection's concept is a nod to the world of art, showing our products as if they were museum pieces.

*“Our furniture are not art works, we admire and respect artists too much to say that, but we treat them as if they were”, admits Elena Castaño-López.*

Museo is just a reflection exercise about the creative work, as art and design are concepts very close among them.

*“After years of experience working with illustrators and creatives, **Elena** and I agree that the dedication and passion with which industrial designers, interior designers and architects undertake each new project is similar to that of any artist. Likewise, they feel connected to the results of their work”, clarifies Esther Castaño-López.*



ESTUDIO SANCAL



MUT



SYLVAIN  
WILLENZ



ANTOINE LESUR  
& MARC VENOT

# DESIGNERS



PEREZOCHANDO



NOTE DESIGN STUDIO



RAFA GARCÍA

# CORE

CORE by Note Design Studio

*Un clásico contemporáneo.*

*The essence of a contemporary classic.*

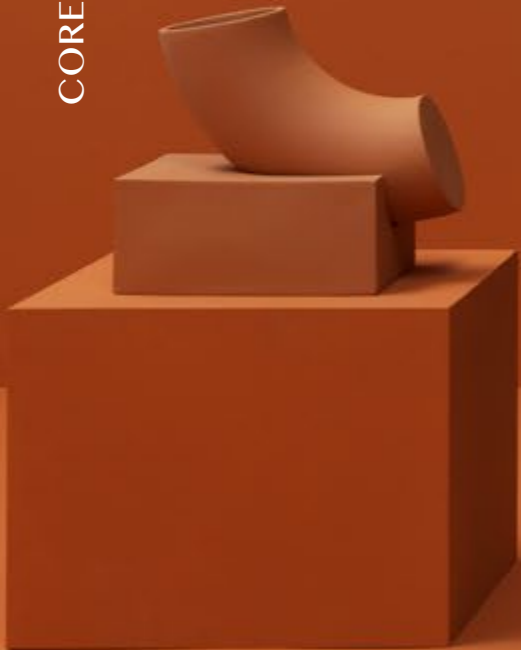

[✕](#)

REFERENCE	DESCRIPTION	UPHOLSTERY OR TOP/BASE	FINISH OR NET	SAMPLE BOOK	SERIES	QTY
356.11.N	CORE ARMCHAIR	FACET 53	-	107.2	4	1
356.11.U	CORE 185 SOFA	GLOW 0923	-	GLOW KVADRAT	7	1

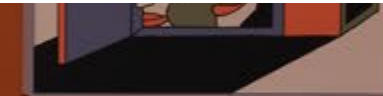
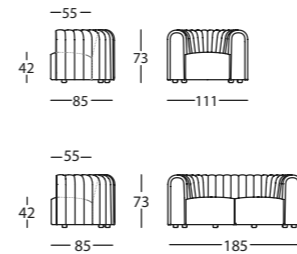

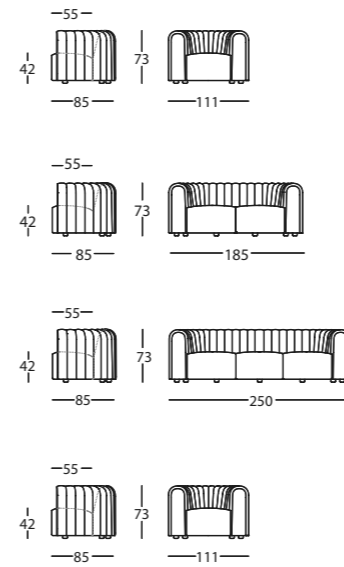

REFERENCE	DESCRIPTION	UPHOLSTERY OR TOP/BASE	FINISH OR NET	SAMPLE BOOK	SERIES	QTY
356.11.N	CORE ARMCHAIR	FACET 1001	-	107.2	4	1
356.11.U	CORE 185 SOFA	GALAXY 0108	-	GALAXY KVADRAT	7	1
356.11.Z1	CORE 250 SOFA	7210	-	127	7	1
356.11.N	CORE ARMCHAIR	FACET 53	-	107.2	4	1



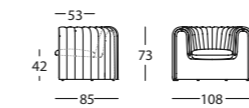

REFERENCE	DESCRIPTION	UPHOLSTERY OR TOP/BASE	FINISH OR NET	SAMPLE BOOK	SERIES	QTY
347.11.N	REMNANT ARMCHAIR	GALAXY 0108	-	GALAXY KVADRAT	7	1
347.11.N	REMNANT ARMCHAIR	5032	-	128	5	1
356.11.U	CORE 185 SOFA	GALAXY 0108	-	GALAXY KVADRAT	7	1
356.11.U	CORE 185 SOFA	5031	-	128	5	1
355.74.LHE	VESTIGE OCCASIONAL TABLE 100X70X41	GLASS/ STAINED ASH	049-GRIS SEDA	-	-	1
347.11.N	REMNANT ARMCHAIR	PLANUM 0411	-	PLANUM FEBRIK KVADRAT	8	1

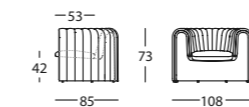
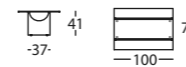
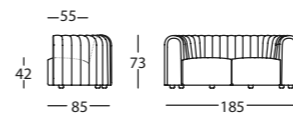
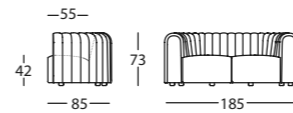
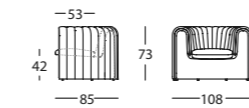

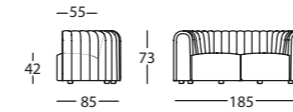

REFERENCE	DESCRIPTION	UPHOLSTERY OR TOP/BASE	FINISH OR NET	SAMPLE BOOK	SERIES	QTY
356.11.U	CORE 185 SOFA	GLOW 0923	-	GLOW KVADRAT	7	1

Su diseño formal, que bien puede traernos a la memoria piezas de inspiración clásica, presenta su faceta más contemporánea a través de los materiales empleados.

Su generosa y confortable sentada está envuelta por el delicado trabajo de confección de los respaldos acolchados. El equilibrio del conjunto reside en la armoniosa unión de sus partes, las cuales encajan naturalmente como elementos cincelados por un escultor, llegando a simular que han sido construidos a partir de un único bloque de materia.

La sobriedad del sillón y los sofás puede ser enfatizada al usar tejidos neutros o verse alterada con divertidos y vivos colores a elegir entre la amplia selección de tejidos acolchados.

inspired furniture and shapes, presents its most contemporary facet through the materials used.

Its generous and comfortable seat is embraced by a delicate quilted back. The balance of the **Core** resides in the harmonious union of its parts, which naturally fit together like elements chiselled by a sculptor, as if they have been built from a single block of material.

The sobriety of the armchair and sofas can be emphasized by using neutral fabrics or contrasted with bold colours.



# REMNANT

REMNANT by Note Design Studio

*Mínima materia, máxima expresión.*

**Remnant** representa el material que el escultor podría haber descartado después de crear **Core**, una interpretación diferente pero complementaria de la misma forma.

*Minimum matter, maximum expression.*

**Remnant** represents the material that the sculptor might have discarded after creating **Core**, a different but complementary interpretation of the same form.

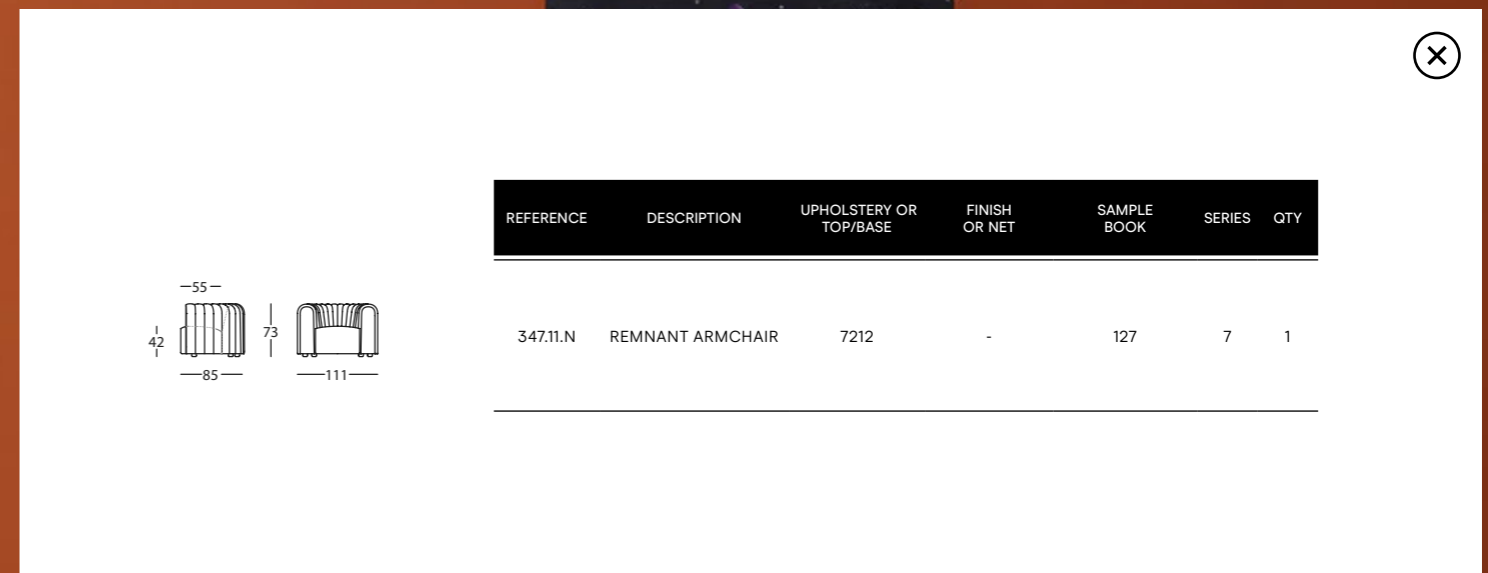

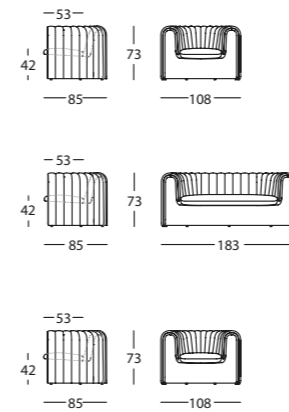

REFERENCE	DESCRIPTION	UPHOLSTERY OR TOP/BASE	FINISH OR NET	SAMPLE BOOK	SERIES	QTY
347.11.N	REMNANT ARMCHAIR	7212	-	127	7	1
347.11.U	REMNANT SOFA	PLANUM 0351	-	PLANUM FEBRIK KVADRAT	8	1
347.11.N	REMNANT ARMCHAIR	PLANUM 0351	-	PLANUM FEBRIK KVADRAT	8	1



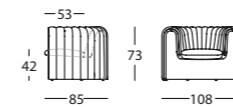
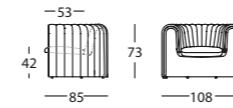
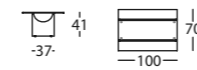
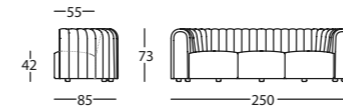

REFERENCE	DESCRIPTION	UPHOLSTERY OR TOP/BASE	FINISH OR NET	SAMPLE BOOK	SERIES	QTY
356.11.Z1	CORE 250 SOFA	7210	-	127	7	1
355.74.LHE	VESTIGE OCCASIONAL TABLE 100X70X41	GLASS/ STAINED ASH	009-CEREZO	-	-	1
347.11.N	REMNANT ARMCHAIR	5032	-	128	5	1
347.11.N	REMNANT ARMCHAIR	PLANUM 0351	-	PLANUM FEBRIK KVADRAT	8	1





✕

REFERENCE	DESCRIPTION	UPHOLSTERY OR TOP/BASE	FINISH OR NET	SAMPLE BOOK	SERIES	QTY
347.11.N	REMNANT ARMCHAIR	PLANUM 0411	-	PLANUM FEBRIK KVADRAT	8	1

una interpretación diferente pero complementaria de la misma forma.

La complejidad técnica de **Remnant** ha sido uno de los grandes retos de este proyecto. Su simulada levedad y aparente simpleza es el fruto de un gran trabajo de experimentación e ingeniería. La esencia del diseño se caracteriza por la fusión perfecta entre la curiosidad industrial por encontrar nuevas formas constructivas, la calidez aportada por el trabajo manual y artesano del tapicero, la elegancia orgánica del diseño y sus impecables detalles.

El sutil y elegante acolchado que envuelve tanto el sillón como el sofá aporta textura a un escultural e icónico diseño que puede ser tapizado en un amplio abanico de tejidos.

different but complementary interpretation of the same form.

The product's technical complexity has been one of the main challenges of this project. Its visual lightness and apparent simplicity are the result of a considerable amount of development, experimentation and engineering. The essence of this design is characterized by the perfect fusion between industrial curiosity to find new constructive forms, the warmth provided by the artisan work of the upholsterer, the elegance of the design and its impeccable details.

The subtle and elegant quilting that surrounds both the armchair and the sofa adds texture to an iconic design that can be upholstered in a wide range of fabrics.

# LAPSO

LAPSO by A. Lesur & M. Venot

*No molestar. Estoy en mi momento **Lapso**.*

*Do not disturb. I'm taking a **Lapso**.*

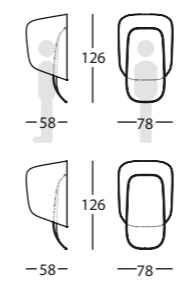

REFERENCE	DESCRIPTION	UPHOLSTERY OR TOP/BASE	FINISH OR NET	SAMPLE BOOK	SERIES	QTY
343.3FA.H	LAPSO HAMACA VERTICAL	CURA 65105	AZUL	CURA GABRIEL	-	1
343.3FA.H	LAPSO HAMACA VERTICAL	RAZZLE DAZZLE GINGER 0466	AZUL	RAZZLE DAZZLE FEBRIK KVADRAT	-	1

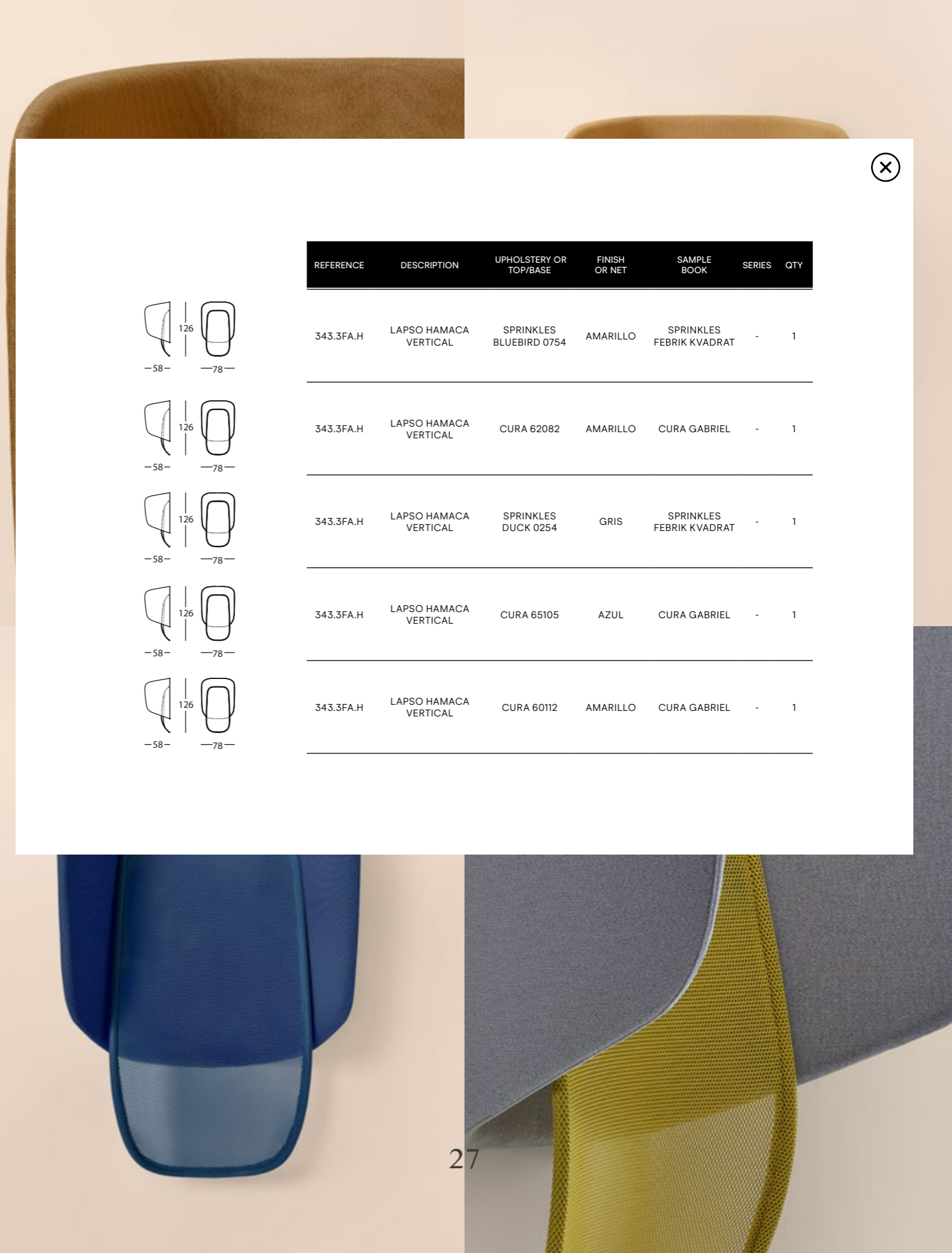

REFERENCE	DESCRIPTION	UPHOLSTERY OR TOP/BASE	FINISH OR NET	SAMPLE BOOK	SERIES	QTY
343.3FA.H	LAPSO HAMACA VERTICAL	SPRINKLES BLUEBIRD 0754	AMARILLO	SPRINKLES FEBRIK KVADRAT	-	1
343.3FA.H	LAPSO HAMACA VERTICAL	CURA 62082	AMARILLO	CURA GABRIEL	-	1
343.3FA.H	LAPSO HAMACA VERTICAL	SPRINKLES DUCK 0254	GRIS	SPRINKLES FEBRIK KVADRAT	-	1
343.3FA.H	LAPSO HAMACA VERTICAL	CURA 65105	AZUL	CURA GABRIEL	-	1
343.3FA.H	LAPSO HAMACA VERTICAL	CURA 60112	AMARILLO	CURA GABRIEL	-	1

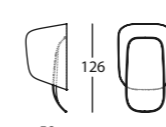
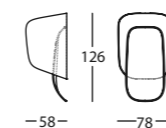
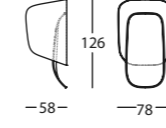
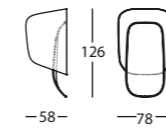
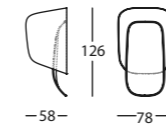

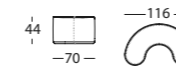
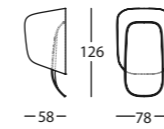
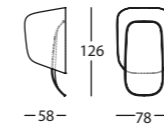

REFERENCE	DESCRIPTION	UPHOLSTERY OR TOP/BASE	FINISH OR NET	SAMPLE BOOK	SERIES	QTY
343.3FA.H	LAPSO HAMACA VERTICAL	SPRINKLES DUCK 0254	GRIS	SPRINKLES FEBRIK KVADRAT	-	2
343.3FA.H	LAPSO HAMACA VERTICAL	RAZZLE DAZZLE NATURAL 0116	NEGRO	RAZZLE DAZZLE FEBRIK KVADRAT	-	1
354.15.EE	DIVIDUALS POUF D42X40	6112	049-GRIS SEDA	115	6	1
354.15.MHE	DIVIDUAL SHAPED POUF 116X70X40	HUSK 0154	049-GRIS SEDA	HUSK FEBRIK KVADRAT	8	1
354.15.DG	DIVIDUALS POUF D38X60	HUSK 0554	009-CEREZO	HUSK FEBRIK KVADRAT	8	1
354.15.EE	DIVIDUALS POUF D42X40	HUSK 0154	049-GRIS SEDA	HUSK FEBRIK KVADRAT	8	1





REFERENCE	DESCRIPTION	UPHOLSTERY OR TOP/BASE	FINISH OR NET	SAMPLE BOOK	SERIES	QTY
-----------	-------------	------------------------	---------------	-------------	--------	-----

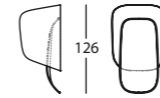

343.3FA.H	LAPSO HAMACA VERTICAL	SPRINKLES DUCK 0254	GRIS	SPRINKLES FEBRIK KVADRAT	-	2
-----------	-----------------------	---------------------	------	--------------------------	---	---

vertical para darle de sus clientes.

Por los materiales con los que está construida, la “capota” es fonoabsorbente y, una vez dentro de ella, contribuye a mejorar la sensación acústica gracias a su amplia curvatura. Ello induce a bajar la voz cuando hablamos por teléfono desde el interior de esta comfortable cabina.

Mejorar la sensación acústica de los espacios públicos es, sin duda, una importante función. Sin embargo, **Lapso** añade un **nuevo tipo de confort** en entornos bulliciosos ya que, como **hamaca vertical**, nos da la posibilidad de disfrutar de un momento de descanso activo en un aeropuerto o hacer una pausa para reflexionar tranquilamente en mitad de la oficina.

La nutrida selección de textiles fonoabsorbentes elegidos para la capota se puede combinar libremente con los 5 colores de malla disponibles, si bien, recomendamos las combinaciones comisionadas por los diseñadores.

this unique vertical hammock, ideal for crowded public spaces, enabling individuals to lean back for a moment's privacy.

The “hood” contributes to improving acoustics thanks to its curved upholstered panels. The shape reflects sound back to the person making a call, causing them to naturally lower their voice, while the padded upholstery helps to dampen the room's reverberation.

Improving acoustics in public spaces is undoubtedly an important function. However, **Lapso** adds one more **unique feature**. It is also a **vertical hammock** where people can lean back and take some time out during a trip or reflect quietly in the middle of a bustling office.

The wide range of textiles with acoustic properties for the hood can be freely combined with 5 mesh colours, although we recommend the combinations curated by the designers.



# VESTIGE

VESTIGE by Note Design Studio

*Belleza pretérita.*

El paso del tiempo es un elemento que esculpe la materia imprimiendo su huella sobre los objetos.



*The beauty of past vestiges.*

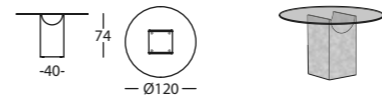



The passage of time is an element that leaves a trace of the past as it sculpts matter.

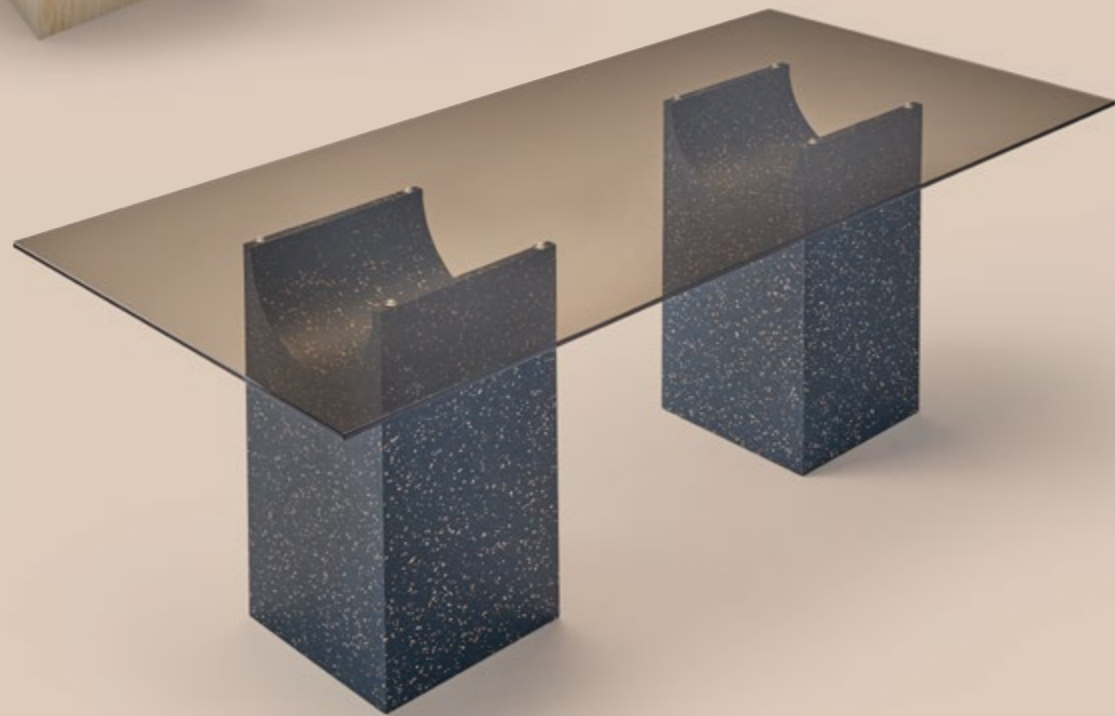
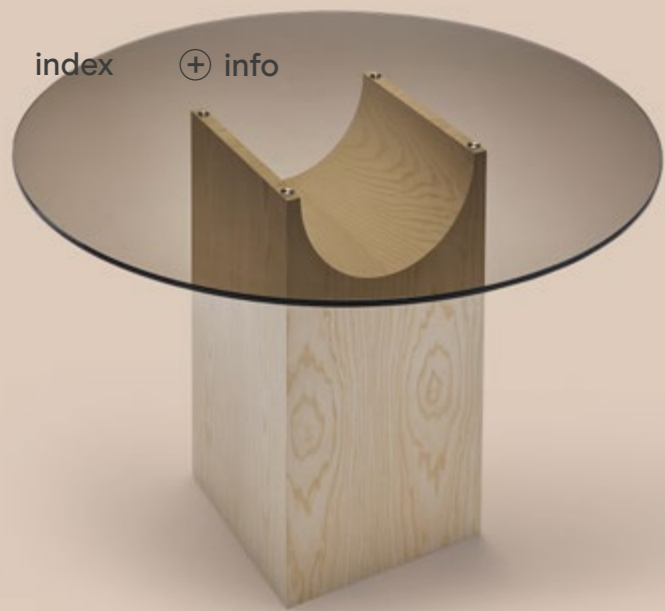

REFERENCE	DESCRIPTION	UPHOLSTERY OR TOP/BASE	FINISH OR NET	SAMPLE BOOK	SERIES	QTY
355.74.NH.CI	VESTIGE TABLE D120X74	GLASS/IQ SURFACE	171-MARINO	-	-	1

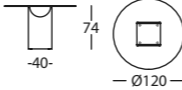

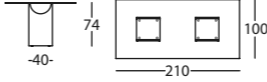
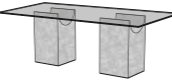
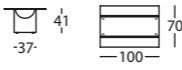
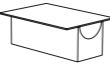
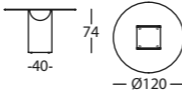
REFERENCE	DESCRIPTION	UPHOLSTERY OR TOP/BASE	FINISH OR NET	SAMPLE BOOK	SERIES	QTY
 	355.74.NH.CT VESTIGE TABLE D120X74	GLASS/ STAINED ASH	002-NATURAL	-	-	1
 	355.74.XLH.CI VESTIGE TABLE 210X100X74	GLASS/IQ SURFACE	171-MARINO	-	-	1
 	355.74. LHE.CT VESTIGE OCCASIONAL TABLE 100X70X41	STAINED ASH	049-GRIS SEDA	-	-	1
 	355.74.NH.CL VESTIGE TABLE D120X74	GLASS/LAQUER	141-NUDE	-	-	1
 	355.74.NH.CI VESTIGE TABLE D120X74	GLASS/IQ SURFACE	171-MARINO	-	-	1

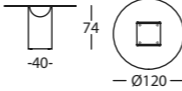
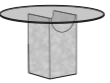

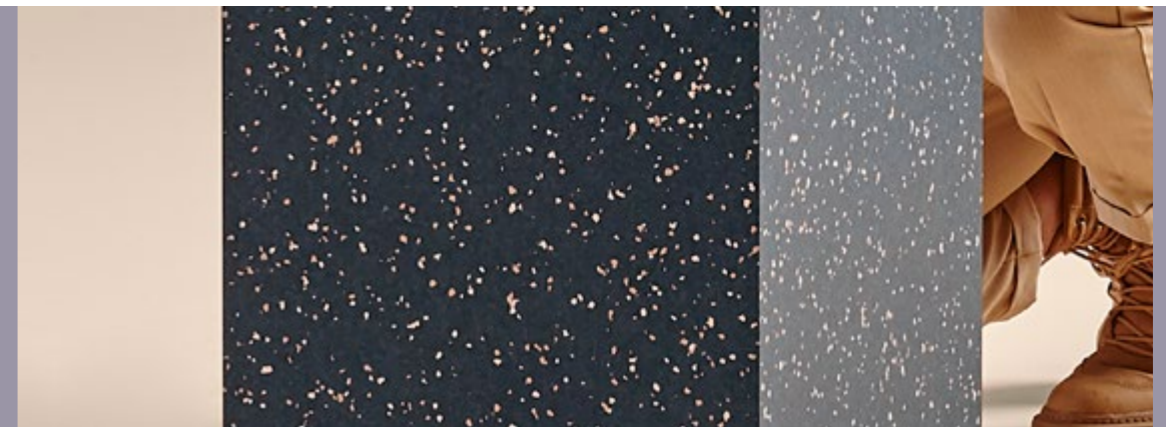

✕

REFERENCE	DESCRIPTION	UPHOLSTERY OR TOP/BASE	FINISH OR NET	SAMPLE BOOK	SERIES	QTY
	355.74. XLH.CT	VESTIGE TABLE 210X100X74	GLASS/ STAINED ASH	003-NOGAL	-	- 1
	349.46.J	ROLL CHAIR	CHESTNUT 805	141-NUDE	CLASSIC 2	12 1
	355.74.NH.CT	VESTIGE TABLE D120X74	GLASS/ STAINED ASH	002-NATURAL	-	- 1
	349.46.J	ROLL CHAIR	2806	124-CHAMPAN	118	3 2

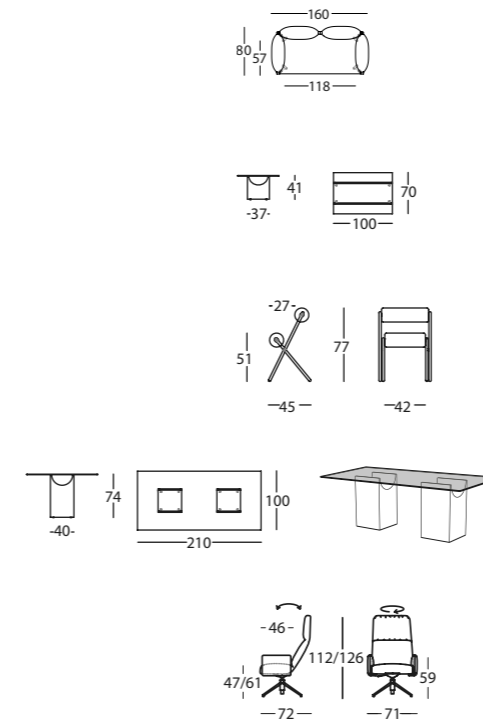

REFERENCE	DESCRIPTION	UPHOLSTERY OR TOP/BASE	FINISH OR NET	SAMPLE BOOK	SERIES	QTY
345.11.R.4	CLICK SOFA 160	GLOW 0343	NEGRO TEXT.	GLOW KVADRAT	7	1
355.74.LHE	VESTIGE OCCASIONAL TABLE 100X70X41	GLASS/IQ SURFACE	171-MARINO	-	-	1
349.46.J	ROLL CHAIR	6253	141-NUDE	126	6	1
355.74.XLH.CT	VESTIGE TABLE 210X100X74	GLASS/ STAINED ASH	003-NOGAL	-	-	1
348.65.4	ELLE EXEC. CHAIR 4 STAR BASE W/ UPH. ARMS	PLANUM 0351	001-BLACK	PLANUM FEBRIK KVADRAT	8	1

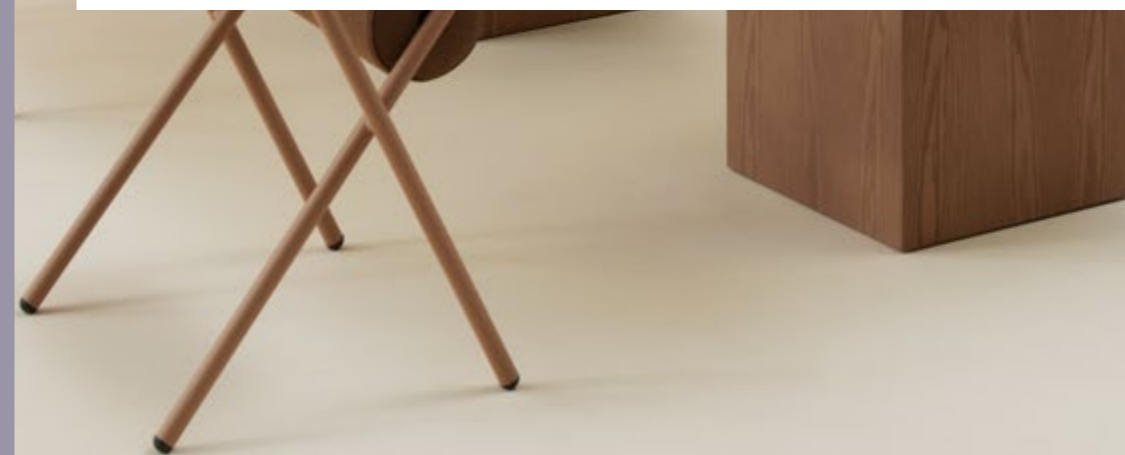



X

REFERENCE	DESCRIPTION	UPHOLSTERY OR TOP/BASE	FINISH OR NET	SAMPLE BOOK	SERIES	QTY
355.74.NH.CI	VESTIGE TABLE D120X74	GLASS/iQ SURFACE	171-MARINO	-	-	1

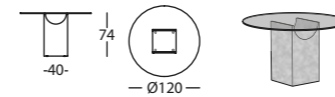

de formas simples.

Por la singularidad de los materiales empleados, la base no solo es el elemento estructural, sino que también lo es estético. La versión de madera de fresno se puede tinter en todos los colores de nuestra carta. Por su parte, **Note** recomienda las nuevas incorporaciones *Menta*, *Lavanda* y *Calabaza*, además de los recurrentes *Nogal* y *Cerezo* por ser las gamas que mejor combinan con el achampanado color del cristal.

La versión **iQ** supone una verdadera experimentación en el uso de materiales, pues tradicionalmente se aplica en construcción a pavimentos y paredes. Partiendo de la paleta diseñada por **Note** para **Tarkett**, seleccionamos *Marino*, un profundo azul salpicado de motitas en tonos nude, por evocar la plácida satisfacción de las perpetuidades marinas.

Finalmente, los acabados **lacados** amplían la gama de colores y aportan un toque extra-mate que realzan el brillo del cristal.

Mientras que las mesitas auxiliares cuentan con tres versiones de tapa (cristal, fresno tintado o dm lacado), las mesas de comedor únicamente están disponibles con tapa de cristal.

The base is both structural and aesthetic. To combine with the champagne hues of the glass top, **Note** studio have curated the brand new *Menta*, *Lavanda* and *Calabaza* stains for the ash wood version of the base, and also recommend our classic *Nogal* and *Cerezo* colours.

We have also repurposed **iQ** from **Tarkett** as an alternative finish for the base: extremely hard wearing, it is normally used on floors and walls. The table launches in *Marino*, a deep mottled blue pattern that has also been designed by **Note**.

Another option is to choose a lacquer colour from our ample range; an extra-matt finish that contrasts with the shine of the glass top.

While occasional tables are available with three different table tops (glass, ash wood or lacquer), dining tables are only available with a glass top.

# DIWAN

DIWAN by PerezOchando

*Un lujo asiático contemporáneo.*

*Oriental luxury for modern life.*

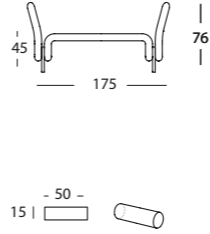

REFERENCE	DESCRIPTION	UPHOLSTERY OR TOP/BASE	FINISH OR NET	SAMPLE BOOK	SERIES	QTY
346.10.S.BR	DIWAN BENCH 175 WITH ARMS	MOSAIC 2 0472	057-CALABAZA	MOSAIC 2 FEBRIK KVADRAT	11	1
100.22.FB	CYLINDER CUSHION 50X15	MOSAIC 2 0472	-	MOSAIC 2 FEBRIK KVADRAT	11	2



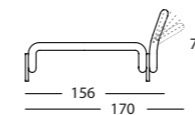
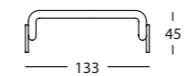
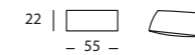
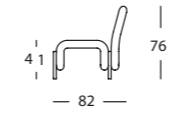

REFERENCE	DESCRIPTION	UPHOLSTERY OR TOP/BASE	FINISH OR NET	SAMPLE BOOK	SERIES	QTY
346.12.H	DIWAN LOUNGE CHAIR	PECTO 0654	041-MALAQUITA	PECTO FEBRIK KVADRAT	9	1
346.27.FC	DIWAN LUMBAR CUSHION 55X22	CURA 68184	-	CURA GABRIEL	5	1
346.10.Q	DIWAN BENCH 140	CURA 61168	108-NEGRO	CURA GABRIEL	5	2
346.14.H.R	DIWAN CHAISE LONGUE RECLINING BACK	HUSK 0974	002-NATURAL	HUSK FEBRIK KVADRAT	8	1



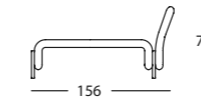
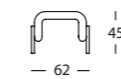
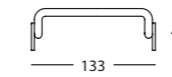
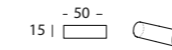
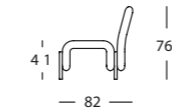
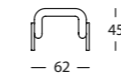
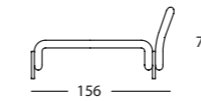

REFERENCE	DESCRIPTION	UPHOLSTERY OR TOP/BASE	FINISH OR NET	SAMPLE BOOK	SERIES	QTY
346.14.H	DIWAN CHAISE LONGUE FIXED BACK	HUSK 0554	009-CEREZO	HUSK FEBRIK KVADRAT	8	1
346.10.G	DIWAN BENCH 62	ATLAS 0671	043-MANGO	ATLAS KVADRAT	6	1
346.12.H	DIWAN LOUNGE CHAIR	HUSK 0454	002-NATURAL	HUSK FEBRIK KVADRAT	8	2
100.22.FB	CYLINDER CUSHION 50X15	NABUK 27	-	NABUK	12	1
346.10.Q	DIWAN BENCH 140	CURA 61168	108-NEGRO	CURA GABRIEL	5	2
346.10.G	DIWAN BENCH 62	HUSK 154	108-NEGRO	HUSK FEBRIK KVADRAT	8	1
346.14.H	DIWAN CHAISE LONGUE FIXED BACK	HUSK 734	002-NATURAL	HUSK FEBRIK KVADRAT	8	1





REFERENCE	DESCRIPTION	UPHOLSTERY OR TOP/BASE	FINISH OR NET	SAMPLE BOOK	SERIES	QTY
354.15.EE	DIVIDUALS POUF D42X40	MOSAIC 2 0472	009-CEREZO	MOSAIC 2 FEBRIK KVADRAT	11	1

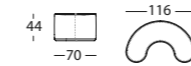

354.15.MHE	DIVIDUAL SHAPED POUF 116X70X40	6119	009-CEREZO	115	6	1
------------	--------------------------------	------	------------	-----	---	---



354.15.DG	DIVIDUALS POUF D38X60	HUSK 0554	009-CEREZO	HUSK FEBRIK KVADRAT	8	1
-----------	-----------------------	-----------	------------	---------------------	---	---

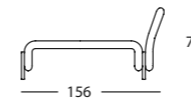

346.14.H	DIWAN CHAISE LONGUE FIXED BACK	HUSK 0734	002-NATURAL	HUSK FEBRIK KVADRAT	8	1
----------	--------------------------------	-----------	-------------	---------------------	---	---



305.71	TORTUGA TABLE D41X45	-	002-NATURAL	-	-	1
--------	----------------------	---	-------------	---	---	---

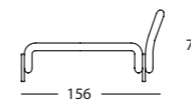

346.14.H	DIWAN CHAISE LONGUE FIXED BACK	HUSK 0554	009-CEREZO	HUSK FEBRIK KVADRAT	8	1
----------	--------------------------------	-----------	------------	---------------------	---	---

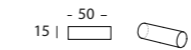

100.22.FB	CYLINDER CUSHION 50X15	NABUK 27	-	NABUK	12	1
-----------	------------------------	----------	---	-------	----	---

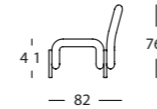
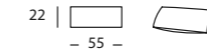
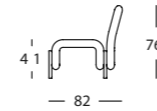
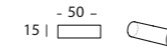
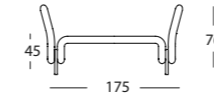
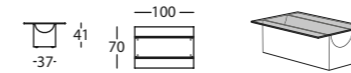
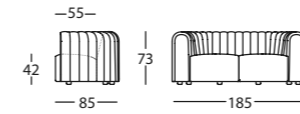

REFERENCE	DESCRIPTION	UPHOLSTERY OR TOP/BASE	FINISH OR NET	SAMPLE BOOK	SERIES	QTY
356.11.U	CORE 185 SOFA	GALAXY 0108	-	GALAXY KVADRAT	7	1
355.74.LHE	VESTIGE OCCASIONAL TABLE 100X70X41	GLASS/ STAINED ASH	049-GRIS SEDA	-	1	1
346.10.S.BR	DIWAN BENCH 175 WITH ARMS	MOSAIC 2 0472	057-CALABAZA	MOSAIC 2 FEBRIK KVADRAT	11	1
100.22.FB	CYLINDER CUSHION 50X15	MOSAIC 2 0472	-	MOSAIC 2 FEBRIK KVADRAT	11	2
346.12.H	DIWAN LOUNGE CHAIR	PLECTO 0654	041-MALAQUITA	PLECTO FEBRIK KVADRAT	9	1
346.27.FC	DIWAN LUMBAR CUSHION 55X22	8070	-	116	7	1
346.12.H	DIWAN LOUNGE CHAIR	GALAXY 0348	052-KLEIN	GALAXY KVADRAT	7	2

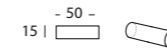
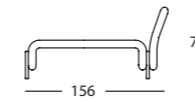

REFERENCE	DESCRIPTION	UPHOLSTERY OR TOP/BASE	FINISH OR NET	SAMPLE BOOK	SERIES	QTY
346.14.H	DIWAN CHAISE LONGUE FIXED BACK	HUSK 0554	009-CEREZO	HUSK FEBRIK KVADRAT	8	1
100.22.FB	CYLINDER CUSHION 50X15	NABUK 27	-	NABUK	12	1

Haciendo gala de la ligereza que caracteriza todas sus creaciones, Claudia y Pedro han reducido a la mínima expresión las sinuosas curvas de asientos y respaldos. Para las patas, de nuevo apuestan por un recurso elemental, cuya sencillez formal, lejos de restar carácter, aporta el toque de distinción. De madera natural o tintadas, para combinar o contrastar con el textil, las patas multiplican las opciones de personalización.

Los bancos, sueltos o unidos a modo de bancada, y el diván, tienen una altura de asiento mayor que las chaise longues y butacas, cuya sentada debe ser más relajada.

Las almohadas riñoneras potencian el confort de las butacas y permiten jugar con los textiles. Los cojines cilíndricos son el complemento ideal para coronar los brazos del diván.

Ya sea para deleitarnos en la soledad del dormitorio, para psicoanalizarnos o disfrutar de charlas con amigos junto al sofá, como banco de museo, o como alargada composición en una amplia zona de espera, las diferentes piezas de la familia **Diwan** te harán sentir como un maharajá.

minimum, bringing an air of lightness to the design. The legs' formal simplicity provides a touch of distinction. Available in natural or stained wood, they can be combined or contrasted with the upholstery.

The benches can be used separately or joined to create long compositions. Designed for sitting, rather than lounging, they have a higher seat height than the divan. The chaise lounges and armchairs provide greater support for more relaxed seating.

The lumber cushions enhance the comfort of the seats and adding another texture of colour to the composition. The cylindrical roll cushions are ideal for the divan's arms and provide another element to play with.

Whether as a coquettish piece for the bedroom or to be enjoyed during long conversations with friends; as a bench for a museum or other public space, a long composition for a large waiting area, the **Diwan** range will offer you a luxury seating.

# DIVIDUALS

DIVIDUALS by Note Design Studio

*Parte y todo.* Note presenta una colección de pufs tapizados que conecta objetos formalmente complementarios.

*Part of the whole.* Note presents a collection of upholstered poufs that connects complementary objects.

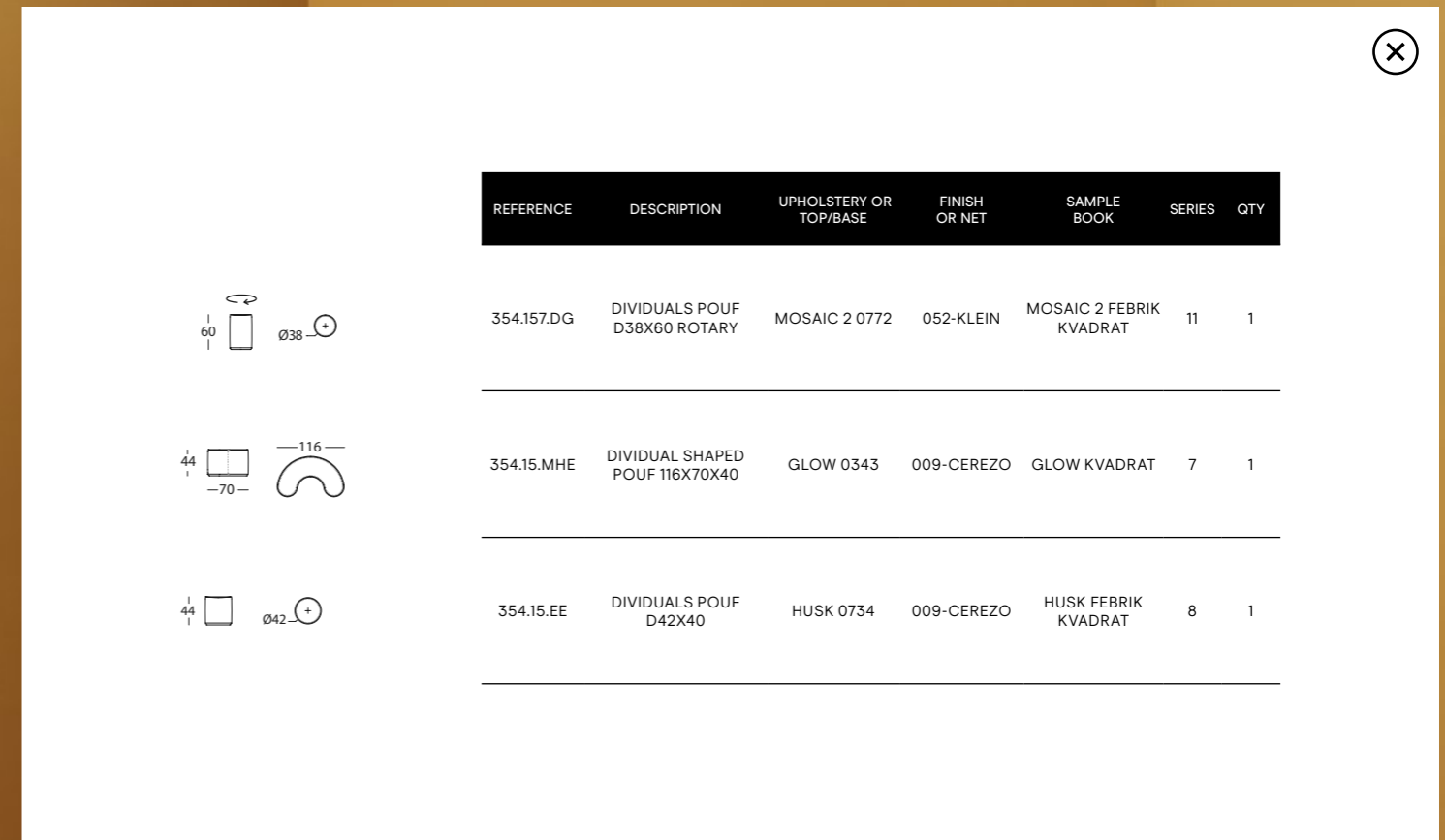

REFERENCE	DESCRIPTION	UPHOLSTERY OR TOP/BASE	FINISH OR NET	SAMPLE BOOK	SERIES	QTY
354.157.DG	DIVIDUALS POUF D38X60 ROTARY	MOSAIC 2 0772	052-KLEIN	MOSAIC 2 FEBRIK KVADRAT	11	1
354.15.MHE	DIVIDUAL SHAPED POUF 116X70X40	GLOW 0343	009-CEREZO	GLOW KVADRAT	7	1
354.15.EE	DIVIDUALS POUF D42X40	HUSK 0734	009-CEREZO	HUSK FEBRIK KVADRAT	8	1

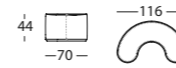

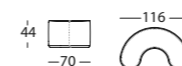
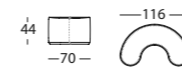
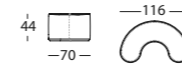



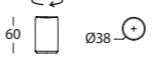
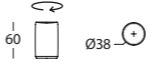
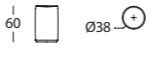
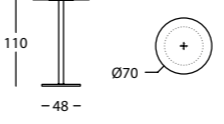
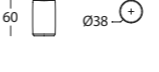
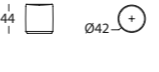
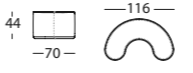
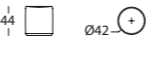

REFERENCE	DESCRIPTION	UPHOLSTERY OR TOP/BASE	FINISH OR NET	SAMPLE BOOK	SERIES	QTY
354.157.DG	DIVIDUALS POUF D38X60 ROTARY	PLECTO 0984	059-MENTA	PLECTO FEBRIK KVADRAT	9	1
354.15.MHE	DIVIDUAL SHAPED POUF 116X70X40	6252	009-CEREZO	126	6	1
354.15.EE	DIVIDUALS POUF D42X40	ATLAS 0561	003-NOGAL	ATLAS KVADRAT	6	1
354.15.DG	DIVIDUALS POUF D38X60	HUSK 0554	009-CEREZO	HUSK FEBRIK KVADRAT	8	1
354.15.EE	DIVIDUALS POUF D42X40	HUSK 0734	009-CEREZO	HUSK FEBRIK KVADRAT	8	1
354.15.MHE	DIVIDUAL SHAPED POUF 116X70X40	CHESTNUT 805	009-CEREZO	CLASSIC 2	12	1
354.15.EE	DIVIDUALS POUF D42X40	5003	009-CEREZO	122	5	1
354.15.DG	DIVIDUALS POUF D38X60	GALAXY 0408	049-GRIS SEDA	GALAXY KVADRAT	7	1
354.15.EE	DIVIDUALS POUF D42X40	6112	049-GRIS SEDA	115	6	1
354.15.MHE	DIVIDUAL SHAPED POUF 116X70X40	HUSK 0154	049-GRIS SEDA	HUSK FEBRIK KVADRAT	8	1

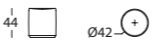
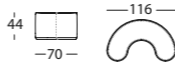
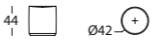
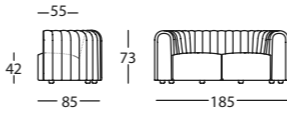
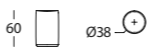

REFERENCE	DESCRIPTION	UPHOLSTERY OR TOP/BASE	FINISH OR NET	SAMPLE BOOK	SERIES	QTY
	354.157.DG	DIVIDUALS POUF D38X60 ROTARY	HUSK 0454	003-NOGAL	HUSK FEBRIK KVADRAT	8 1
	354.157.DG	DIVIDUALS POUF D38X60 ROTARY	GALAXY 0408	049-GRIS SEDA	GALAXY KVADRAT	7 1
	354.157.DG	DIVIDUALS POUF D38X60 ROTARY	PLECTO 0984	059-MENTA	PLECTO FEBRIK KVADRAT	9 1
	354.15.DG	DIVIDUALS POUF D38X60	5020	049-GRIS SEDA	128	5 1
	318.79. D70X110	DUMBBELL TABLE D70X110	-	POLYREY ROC BRIQUE/127-BRIQUE	-	- 1
	354.15.DG	DIVIDUALS POUF D38X60	HUSK 0554	009-CEREZO	HUSK FEBRIK KVADRAT	8 1
	354.15.EE	DIVIDUALS POUF D42X40	5003	003-NOGAL	122	5 1
	354.15.MHE	DIVIDUAL SHAPED POUF 116X70X40	6252	009-CEREZO	126	6 1
	354.15.EE	DIVIDUALS POUF D42X40	PLATA	003-NOGAL	-	12 1

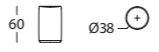
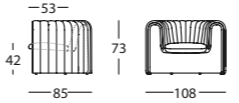
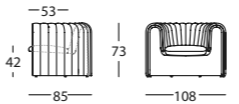
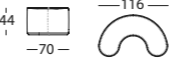

REFERENCE	DESCRIPTION	UPHOLSTERY OR TOP/BASE	FINISH OR NET	SAMPLE BOOK	SERIES	QTY
	354.15.EE DIVIDUALS POUF D42X40	HUSK 0154	049-GRIS SEDA	HUSK FEBRIK KVADRAT	8	1
	354.15.MHE DIVIDUAL SHAPED POUF 116X70X40	HUSK 0154	049-GRIS SEDA	HUSK FEBRIK KVADRAT	8	1
	354.15.EE DIVIDUALS POUF D42X40	PLECTO 0934	059-MENTA	PLECTO FEBRIK KVADRAT	9	1
	356.11.U CORE 185 SOFA	GLOW 0923	-	GLOW KVADRAT	7	1
	354.15.DG DIVIDUALS POUF D38X60	5020	049-GRIS SEDA	128	5	1
	305.71 TORTUGA TABLE D41X45	-	002-NATURAL	-	-	2
	354.15.DG DIVIDUALS POUF D38X60	GALAXY 0408	049-GRIS SEDA	GALAXY KVADRAT	7	1
	347.11.N REMNANT ARMCHAIR	7212	-	127	7	1
	347.11.N REMNANT ARMCHAIR	GALAXY 0108	-	GALAXY KVADRAT	7	1
	354.15.MHE DIVIDUAL SHAPED POUF 116X70X40	GLOW 0343	009-CEREZO	GLOW KVADRAT	7	1
	354.15.EE DIVIDUALS POUF D42X40	6112	049-GRIS SEDA	115	6	1



REFERENCE	DESCRIPTION	UPHOLSTERY OR TOP/BASE	FINISH OR NET	SAMPLE BOOK	SERIES	QTY
354.15.MHE	DIVIDUAL SHAPED POUF 116X70X40	HUSK 0684	009-CEREZO	HUSK FEBRIK KVADRAT	8	1
354.15.DG	DIVIDUALS POUF D38X60	HUSK 0554	009-CEREZO	HUSK FEBRIK KVADRAT	8	1

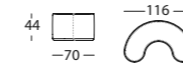

configura cobra un sentido u otro.

**Dividuals** forma parte del concepto **Void Matters**, según el cual **Note** explora los efectos que ambos lados de la materia tienen sobre el espacio, prestando especial atención a cómo la ausencia de la misma define la forma de un objeto. Por ello, no es de extrañar que uno de los rasgos más característicos de los pufs sea su asiento invertido o “vacío” como elemento de diseño.

Combinando o contrastando entre sí los textiles disponibles y los 22 colores de tintes disponibles para el sutil zócalo de madera de fresno maciza, la plasticidad de los pufs **Dividuals** permite la creación de sets tan estéticos como funcionales.

Un detalle funcional y juguetón es que el puf D38x60 tiene una variante giratoria, además de su versión fija.

through which **Note** explores matter, paying special attention to how its absence defines the shape of an object. Therefore, it is not surprising that one of the most characteristic features of these pufs is their inverted or “empty” seat.

Combining or contrasting the textiles and the 22 stain colours available for the ash solid wood plinth, the plasticity of the **Dividuals** pufs allows the creation of aesthetic and functional sets.

A subtle and playful detail is that the D38x60 pouf is available with a swivel mechanism, in addition to its fixed version.



# TOTEM

TOTEM by Sylvain Willenz

Según el diccionario, un tótem es una pieza icónica con cualidades espirituales vinculadas a una tribu o un individuo.

The dictionary definition of a totem is an iconic piece, or a special symbol, to which spiritual significance is attached.

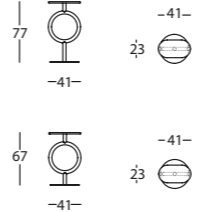

REFERENCE	DESCRIPTION	UPHOLSTERY OR TOP/BASE	FINISH OR NET	SAMPLE BOOK	SERIES	QTY
353.46.H	TOTEM STOOL 77	RAZZLE DAZZLE NATURAL 0116	001 NEGRO	RAZZLE DAZZLE FEBRIK KVADRAT	9	1
353.46.G	TOTEM STOOL 67	RAZZLE DAZZLE NATURAL 0116	001 NEGRO	RAZZLE DAZZLE FEBRIK KVADRAT	9	1



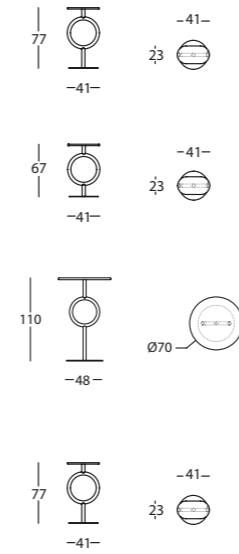

REFERENCE	DESCRIPTION	UPHOLSTERY OR TOP/BASE	FINISH OR NET	SAMPLE BOOK	SERIES	QTY
353.46.H	TOTEM STOOL 77	CHESTNUT 805	139-CASTAÑO	CLASSIC 2	12	1
353.46.G	TOTEM STOOL 67	CHESTNUT 805	139-CASTAÑO	CLASSIC 2	12	1
353.71.HM	TOTEM TABLE	057 CALABAZA	139-CASTAÑO			
353.46.H	TOTEM STOOL 77	ATLANTIC 61166	124 CHAMPAGE	112	2	1



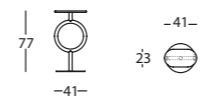
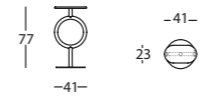
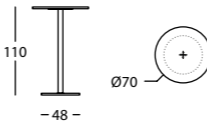
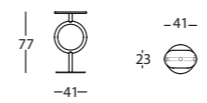
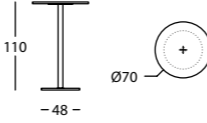

✕

REFERENCE	DESCRIPTION	UPHOLSTERY OR TOP/BASE	FINISH OR NET	SAMPLE BOOK	SERIES	QTY
	353.46.H TOTEM STOOL 77	GLOW 0343	141-NUDE	GLOW KVADRAT	7	2
	353.46.H TOTEM STOOL 77	CHESTNUT 805	139-CASTAÑO	CLASSIC 2	12	2
	318.79. D70X110 DUMBBELL TABLE D70X110	-	POLYREY ROC BRIQUE/127-BRIQUE	-	-	1
	353.46.H TOTEM STOOL 77	RAZZLE DAZZLE NATURAL 0116	001 NEGRO	RAZZLE DAZZLE FEBRIK KVADRAT	9	2
	318.79. D70X110 DUMBBELL TABLE D70X110	-	POLYREY ROC NEGRO/001-NOIR	-	-	1



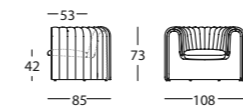
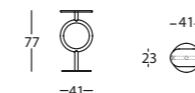
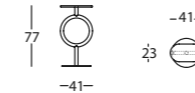
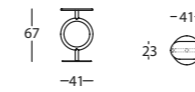
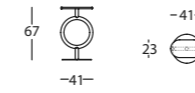
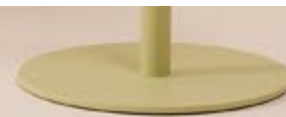

REFERENCE	DESCRIPTION	UPHOLSTERY OR TOP/BASE	FINISH OR NET	SAMPLE BOOK	SERIES	QTY
353.46.G	TOTEM STOOL 67	HUSK 0684	125-BERENJENA	HUSK FEBRIK KVADRAT	8	1
353.46.G	TOTEM STOOL 67	CHESTNUT 805	139-CASTAÑO	CLASSIC 2	12	1
353.46.H	TOTEM STOOL 77	ATLANTIC 61166	124 CHAMPAGE	112	2	2
353.46.H	TOTEM STOOL 77	HUSK 0684	125-BERENJENA	HUSK FEBRIK KVADRAT	8	1
354.15.EE	DIVIDUALS POUF D42X40	ATLAS 0561	003-NOGAL	ATLAS KVADRAT	6	1
347.11.N	REMNANT ARMCHAIR	6252	-	126	6	



REFERENCE	DESCRIPTION	UPHOLSTERY OR TOP/BASE	FINISH OR NET	SAMPLE BOOK	SERIES	QTY
353.46.H	TOTEM STOOL 77	CHESTNUT 805	139-CASTAÑO	CLASSIC 2	12	1
353.46.G	TOTEM STOOL 67	CHESTNUT 805	139-CASTAÑO	CLASSIC 2	12	1

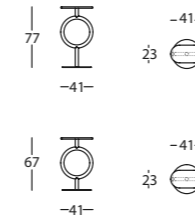

firme y robusta, pues su amplia base estabiliza el frágil equilibrio que resulta de una recta apoyada sobre un círculo. El aro central, además de equilibrar, atesora todo el carácter y sirve de reposapiés en el caso del taburete. Aun reducido a lo esencial, el asiento realza el confort y los volúmenes de una pieza casi bidimensional.

Tras el taburete, era lógica la evolución de **Totem** hacia una versátil familia de mesas y mesitas. La variedad de alturas y diámetros disponible amplía su funcionalidad y permite destinarlas a usos tan diversos como: mesita de centro y de noche, mesa de comedor, mesa alta de cocktail y hasta mesa de tertulia, de altura intermedia, a la que acompañar con cómodas butacas.

Además de la larga lista de pieles y textiles con las que tapizar el asiento, éste también está disponible en madera de roble, multiplicando de forma exponencial su expresividad. Tanto el taburete como la mesa comparten la misma estructura metálica, que se puede lacar en una selección de 16 colores. En el caso de las mesas, el sobre de DM se puede lacar a juego del color la estructura. Los sobres de roble se pueden tinter en los 22 acabados de nuestra carta.

Ya sea en casa o en un bar, **Totem** es una interesante alternativa para personalizar un sinfín de ambientes.

comfortable without breaking the illusion of a two-dimensional drawing.

After the stool, the evolution of **Totem** towards a versatile family of tables and occasional tables was logical. The variety of heights and diameters available extend their functionality and allows them to be used for such diverse uses as: coffee or bedside table, dining table, high cocktail table and even medium-height gathering table, which can be accompanied by soft lounge chairs.

Both the stool and table share the same metal structure, which can be lacquered from a selection of 16 colours with matching MDF tabletop. Alternatively, a solid oak top or seat can be fitted which can be stained from a wide selection of 22 colours. The seats can also be upholstered in any of Sancal's leathers or fabrics.

Whether at home or in a bar, **Totem** is an interesting alternative for versatile and chic environments.

# ELLE

ELLE by Rafa García

Elle se empodera tanto en el trabajo como en el hogar. Por ello está disponible como **butaca, sillón orejero y sillón de dirección.**

Elle, empowering, both at work and at home. Available as a **lounge chair, wing chair and executive chair.**

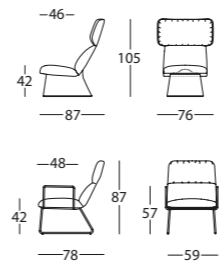

REFERENCE	DESCRIPTION	UPHOLSTERY OR TOP/BASE	FINISH OR NET	SAMPLE BOOK	SERIES	QTY
348.63.T	ELLE WING CHAIR W/ UPHOLSTERED BASE	NABUK 11	-	NABUK	12	1
348.51.BT7	ELLE LOUNGE CHAIR SLED BASE W/METAL ARMS	NITTO 0427	001-NEGRO	NITTO FEBRIK KVADRAT	7	1



index [+](#) info

Sillón orejero  
Wing chair



ELLE by Rafa García

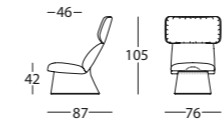

REFERENCE	DESCRIPTION	UPHOLSTERY OR TOP/BASE	FINISH OR NET	SAMPLE BOOK	SERIES	QTY
348.63.T	ELLE WING CHAIR W/ UPHOLSTERED BASE	NABUK 11	-	NABUK	12	1
348.63.BT	ELLE WING CHAIR SLED BASE	5020	001-NEGRO	128	5	1
348.65.OJ4	ELLE WING CHAIR 4 STAR BASE W/ UPH. ARMS	5020	001-NEGRO	128	5	1
348.63.7	ELLE WING CHAIR 4 LEG STRUCT. W/ARMS	SIENA 801	139-CASTAÑO	CLASSIC 2	12	1
348.55.4	ELLE LOUNGE CHAIR 4 STAR BASE W/ UPH. ARMS	PLANUM 0571	001-NEGRO	PLANUM FEBRIK KVADRAT	8	1
348.51.BT7	ELLE LOUNGE CHAIR SLED BASE W/METAL ARMS	PLANUM 0571	001-NEGRO	PLANUM FEBRIK KVADRAT	8	1
348.55	ELLE LOUNGE CHAIR 4 STAR BASE	PLANUM 0571	001-BLACK	PLANUM FEBRIK KVADRAT	8	1
348.51.7	ELLE LOUNGE CHAIR 4 LEG STRUCT. W/ARMS	PLANUM 0741	140-PISCINA	PLANUM FEBRIK KVADRAT	8	1

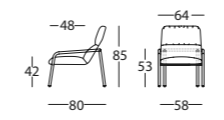
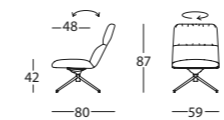
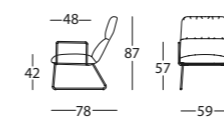
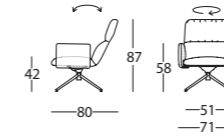
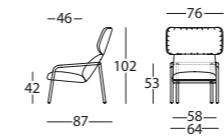
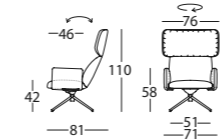
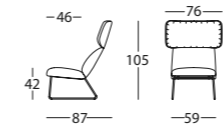

index [+](#) info

Sillón de dirección  
Executive chair



ELLE by Rafa García

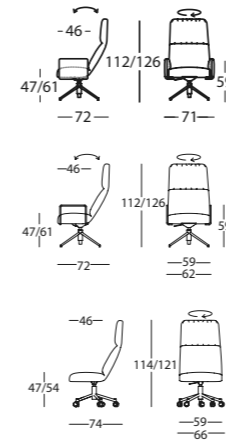

REFERENCE	DESCRIPTION	UPHOLSTERY OR TOP/BASE	FINISH OR NET	SAMPLE BOOK	SERIES	QTY
348.65.4	ELLE EXEC. CHAIR 4 STAR BASE W/ UPH. ARMS	PLANUM 0351	001-NEGRO	PLANUM FEBRIK KVADRAT	8	1
348.65.7	ELLE EXEC. CHAIR 4 STAR BASE W/ METAL ARMS	PLANUM 0351	001-NEGRO	PLANUM FEBRIK KVADRAT	8	1
348.65.9	ELLE EXEC. CHAIR 5 STAR BASE W/ WHEELS	MOSAIC 2 0922	001-NEGRO	MOSAIC 2 FEBRIK KVADRAT	11	1







X

REFERENCE	DESCRIPTION	UPHOLSTERY OR TOP/BASE	FINISH OR NET	SAMPLE BOOK	SERIES	QTY
	348.55 ELLE LOUNGE CHAIR 4 STAR BASE	NITTO 0527	001-NEGRO	NITTO FEBRIK KVADRAT	7	1
	305.71 TORTUGA TABLE D41X45	-	002-NATURAL	-	-	1
	348.55 ELLE LOUNGE CHAIR 4 STAR BASE	NITTO 0427	001-NEGRO	NITTO FEBRIK KVADRAT	7	1
	348.65.7 ELLE EXEC. CHAIR 4 STAR BASE W/ METAL ARMS	MOSAIC 2 0922	001-NEGRO	MOSAIC 2 FEBRIK KVADRAT	11	1
	355.74.XLH.CI VESTIGE TABLE 210X100X74	GLASS/IQ SURFACE	171-MARINO	-	-	1

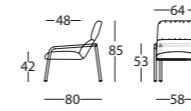

REFERENCE	DESCRIPTION	UPHOLSTERY OR TOP/BASE	FINISH OR NET	SAMPLE BOOK	SERIES	QTY
348.51.7	ELLE LOUNGE CHAIR 4 LEG STRUCT. W/ARMS	PLANUM 0571	125-BERENJENA	PLANUM FEBRIK KVADRAT	8	1
354.15.EE	DIVIDUALS POUF D42X40	MOSAIC 2 0682	056-ROJO	MOSAIC 2 FEBRIK KVADRAT	11	1
348.51.7	ELLE LOUNGE CHAIR 4 LEG STRUCT. W/ARMS	PLANUM 0741	140-PISCINA	PLANUM FEBRIK KVADRAT	8	1
343.3FA.H	LAPSO HAMACA VERTICAL	SPRINKLES BLUEBIRD 0754	AMARILLO	SPRINKLES FEBRIK KVADRAT	-	1
348.51.BT7	ELLE LOUNGE CHAIR SLED BASE W/METAL ARMS	PLANUM 0741	001-NEGRO	PLANUM FEBRIK KVADRAT	8	1
305.71	TORTUGA TABLE D41X45	-	002-NATURAL	-	-	1
348.51.BT7	ELLE LOUNGE CHAIR SLED BASE W/METAL ARMS	PLANUM 0571	001-NEGRO	PLANUM FEBRIK KVADRAT	8	1

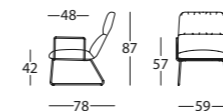
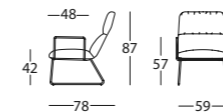
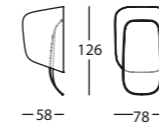
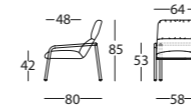

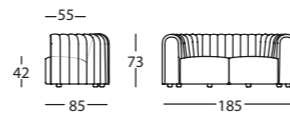
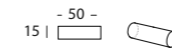
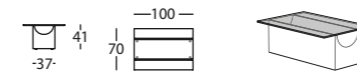
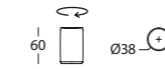
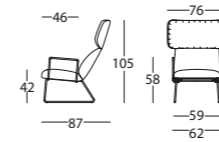
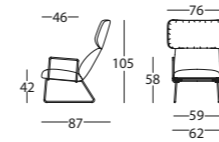

REFERENCE	DESCRIPTION	UPHOLSTERY OR TOP/BASE	FINISH OR NET	SAMPLE BOOK	SERIES	QTY
348.63.BT7	ELLE WING CHAIR SLED BASE W/ METAL ARMS	TAUPE 823	138-ALPINO	CLASSIC 2	12	1
354.15.EE	DIVIDUALS POUF D42X40	5003	003-NOGAL	122	5	1
348.63.BT7	ELLE WING CHAIR SLED BASE W/ METAL ARMS	6108	001-NEGRO	114	6	1
354.157.DG	DIVIDUALS POUF D38X60 ROTARY	5020	049-GRIS SEDA	128	5	1
355.74.LHE	VESTIGE OCCASIONAL TABLE 100X70X41	GLASS/ STAINED ASH	009-CEREZO	-	-	1
100.22.FB	CYLINDER CUSHION 50X15	NABUK 27	-	NABUK	12	1
356.11.Z1	CORE 250 SOFA	7210	-	127	7	1



X

REFERENCE	DESCRIPTION	UPHOLSTERY OR TOP/BASE	FINISH OR NET	SAMPLE BOOK	SERIES	QTY
348.51.BT7	ELLE LOUNGE CHAIR SLED BASE W/METAL ARMS	NITTO 0527	001-NEGRO	NITTO FEBRIK KVADRAT	7	1
305.71	TORTUGA TABLE D41X45	-	002-NATURAL	-	-	1

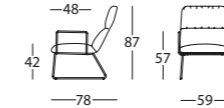

un toque extra de distinción y personalización, pues cualquiera de ellos está disponible en los 16 colores de nuestra carta de lacados. Así, **Elle** es capaz de adaptarse a todo tipo de estilos.

El **sillón de dirección** incorpora una base giratoria con forma de aspa. Es regulable en altura por medio de cartucho de gas. Se puede elegir entre una base de cuatro radios que incorpora un mecanismo balancín bloqueable con accionador o una versión de cinco radios con ruedas.

Para la **butaca** y el **sillón orejero** también hay disponible una base de cuatro radios. Para esta opción el mecanismo giratorio es autocentrante y con efecto "balancín", bloqueable con accionador. Otras opciones de bases son una estructura de cuatro patas con brazos o una base patín.

El uso de tejidos más técnicos y una paleta de colores vibrante crearán intensos contrastes para entornos de trabajo informales y frescos.

**Elle, empowering, both at work and at home.**

**Rafa García's** latest design for **Sancal** is available in several versions. The most coquettish of them is the light **lounge chair** while the cosiest is, without a doubt, the **wing chair**. However, perhaps the most unexpected piece is the **executive chair**, the first design of the firm in this category.

Each type is available in a range of configurations and finishes for working or relaxing at home or in the office. Add a dash of colour by lacquering any of the metal elements from our ample

comfort to the **wing chair** by choosing an upholstered base, exclusive to this variant, with or without upholstered arms.

Apart from the four - legged structure, with incorporated arms, all the other configurations are available with metal or upholstered arms, or without any at all.

In corporate contexts, these different versions can be combined with each other to provide coherence. The selection of more refined fabrics such as velvet and leather in neutral hues will help to create a chic and soft atmosphere. Fabrics with a vibrant colour palette, on the other hand, will create interesting and intense contrasts for informal, fresh work environments.

# CLICK

CLICK by Estudio Sancal

*Sencillo y práctico... listo en un **Click**.*

*Easy, practical ... and ready in a **Click**.*

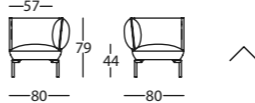
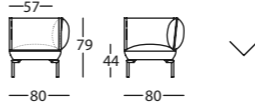
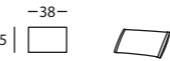

REFERENCE	DESCRIPTION	UPHOLSTERY OR TOP/BASE	FINISH OR NET	SAMPLE BOOK	SERIES	QTY
 345.12.H.4.I	CLICK MODULE 80 LEFT ARM	5004	NEGRO TEXT.	122	5	1
 345.12.H.4.D	CLICK MODULE 80 RIGHT ARM	5004	NEGRO TEXT.	122	5	1
 345.22.DC	COJIN	PLECTO 0444	-	PLECTO FEBRIK KVADRAT	9	1



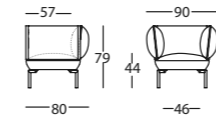

REFERENCE	DESCRIPTION	UPHOLSTERY OR TOP/BASE	FINISH OR NET	SAMPLE BOOK	SERIES	QTY
-----------	-------------	------------------------	---------------	-------------	--------	-----

345.11.K.4	CLICK ARMCHAIR 90	6122	NEGRO TEXT.	115	6	1
------------	-------------------	------	-------------	-----	---	---



345.79.E	CLICK SIDE TABLE 27X39	-	002 NATURAL / NEGRO TEXT.	-	-	2
----------	------------------------	---	---------------------------	---	---	---

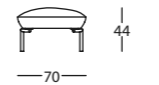

345.15.G	CLICK POUF 69X69	HUSK 0124	NEGRO TEXT.	HUSK FEBRIK KVADRAT	8	2
----------	------------------	-----------	-------------	---------------------	---	---

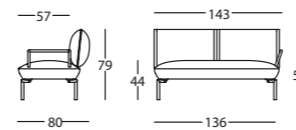

345.12.Q.7.D	CLICK MODULE 143 RIGHT METAL ARM	HUSK 0124	NEGRO TEXT.	HUSK FEBRIK KVADRAT	8	1
--------------	----------------------------------	-----------	-------------	---------------------	---	---

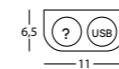

345.2H.MIX	CLICK ELECTRIC SET 1 PLUG BASE + 1 USB	-	-	-	-	1
------------	--	---	---	---	---	---



CLICK by Estudio Sancal

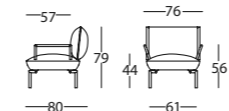
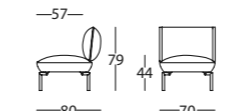
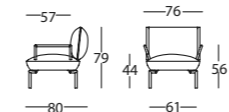
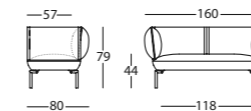
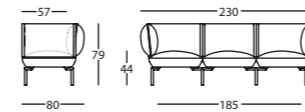

REFERENCE	DESCRIPTION	UPHOLSTERY OR TOP/BASE	FINISH OR NET	SAMPLE BOOK	SERIES	QTY
-----------	-------------	------------------------	---------------	-------------	--------	-----

345.11.Z.4	CLICK SOFA 230	GLOW 0543	NEGRO TEXT.	GLOW KVADRAT	7	1
------------	----------------	-----------	-------------	--------------	---	---

345.11.R.4	CLICK SOFA 160	GLOW 0343	NEGRO TEXT.	GLOW KVADRAT	7	1
------------	----------------	-----------	-------------	--------------	---	---

345.11.H.7	CLICK ARMCHAIR 76 METAL ARM	PLECTO 0934	NEGRO TEXT.	PLECTO FEBRIK KVADRAT	9	1
------------	-----------------------------	-------------	-------------	-----------------------	---	---

354.12.H	CLICK MODULE 70	HUSK 0734	NEGRO TEXT.	HUSK FEBRIK KVADRAT	8	1
----------	-----------------	-----------	-------------	---------------------	---	---

345.11.H.7	CLICK ARMCHAIR 76 METAL ARM	GLOW 0733	NEGRO TEXT.	GLOW KVADRAT	7	1
------------	-----------------------------	-----------	-------------	--------------	---	---





REFERENCE	DESCRIPTION	UPHOLSTERY OR TOP/BASE	FINISH OR NET	SAMPLE BOOK	SERIES	QTY
-----------	-------------	------------------------	---------------	-------------	--------	-----

305.71	TORTUGA TABLE D41X45	-	002-NATURAL	-	-	1
--------	-------------------------	---	-------------	---	---	---

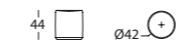

354.15.EE	DIVIDUALS POUF D42X40	MOSAIC 2 0472	009-CEREZO	MOSAIC 2 FEBRIK KVADRAT	11	1
-----------	--------------------------	---------------	------------	----------------------------	----	---

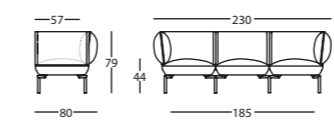

345.11.Z.4	CLICK SOFA 230	GLOW 0543	NEGRO TEXT.	GLOW KVADRAT	7	1
------------	----------------	-----------	-------------	--------------	---	---

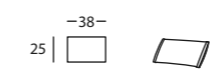

345.22.DC	CLICK CUSHION 38X25	PLECTO 0444	-	PLECTO FEBRIK KVADRAT	9	
-----------	------------------------	-------------	---	--------------------------	---	--

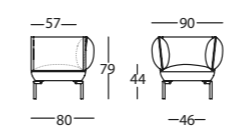

345.11.K.4	CLICK ARMCHAIR 90	NABUK 27	NEGRO TEXT.	NABUK	12	1
------------	-------------------	----------	-------------	-------	----	---



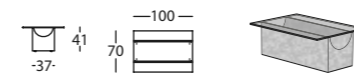
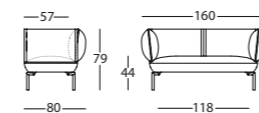
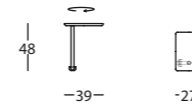
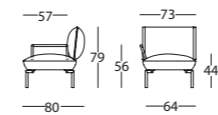
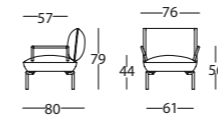
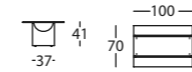
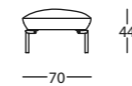
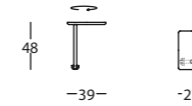
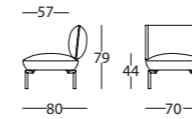
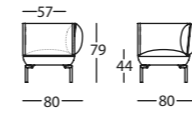

REFERENCE	DESCRIPTION	UPHOLSTERY OR TOP/BASE	FINISH OR NET	SAMPLE BOOK	SERIES	QTY
345.12.H.4.D	CLICK MODULE 80 RIGHT ARM	5004	NEGRO TEXT.	122	5	2
354.12.H	CLICK MODULE 70	5004	NEGRO TEXT.	122	5	2
345.79.E	CLICK SIDE TABLE 27X39	-	002 NATURAL / NEGRO TEXT.	-	-	2
345.15.G	CLICK POUF 70X70	5004	NEGRO TEXT.	122	5	2
355.74.LHE	VESTIGE OCCASIONAL TABLE 100X70X41	GLASS/ STAINED ASH	058-LAVANDA	-	-	1
345.11.H.7	CLICK ARMCHAIR 76 METAL ARM	GLOW 0733	NEGRO TEXT.	GLOW KVADRAT	7	1
345.12.H.7.1	CLICK MODULE 73 LEFT METAL ARM	PLECTO 0934	NEGRO TEXT.	PLECTO FEBRIK KVADRAT	9	1
345.79.E	CLICK SIDE TABLE 27X39	-	001-BLACK / NEGRO TEXT.	-	-	1
354.15.EE	DIVIDUALS POUF D42X40	PLECTO 0934	059-MENTA	PLECTO FEBRIK KVADRAT	9	1
354.15.EE	DIVIDUALS POUF D42X40	HUSK 0154	049-GRIS SEDA	HUSK FEBRIK KVADRAT	8	1
345.11.R.4	CLICK SOFA 160	GLOW 0343	NEGRO TEXT.	GLOW KVADRAT	7	1
355.74.LHE	VESTIGE OCCASIONAL TABLE 100X70X41	GLASS/IQ SURFACE	171-MARINO	-	-	1



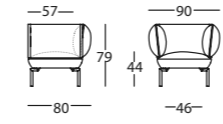

REFERENCE	DESCRIPTION	UPHOLSTERY OR TOP/BASE	FINISH OR NET	SAMPLE BOOK	SERIES	QTY
345.11.K.4	CLICK ARMCHAIR 90	NABUK 27	NEGRO TEXT.	NABUK	12	1
345.12.H.4.D	CLICK MODULE 80 RIGHT ARM	5004	NEGRO TEXT.	122	5	1
354.12.H	CLICK MODULE 70	5004	NEGRO TEXT.	122	5	2
345.161.H	CLICK RIGHT CORNER 80X80	5004	NEGRO TEXT.	122	5	1
345.12.H.4.I	CLICK MODULE 80 LEFT ARM	5004	NEGRO TEXT.	122	5	1
100.22.FB	CYLINDER CUSHION 50X15	NABUK 27	-	NABUK	12	1
345.22.DC	CLICK CUSHION 38X25	PLECTO 444	-	PLECTO FEBRIK KVADRAT	9	
355.74.LHE	VESTIGE OCCASIONAL TABLE 100X70X41	GLASS/ STAINED ASH	009-CEREZO	-	-	1

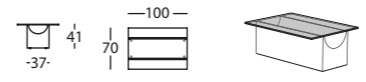
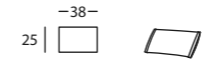
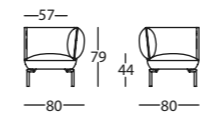
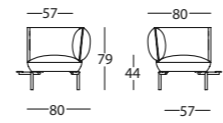
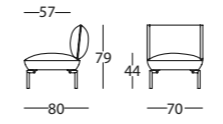
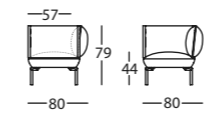

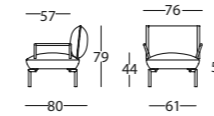
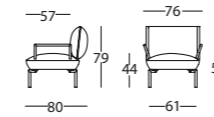

REFERENCE	DESCRIPTION	UPHOLSTERY OR TOP/BASE	FINISH OR NET	SAMPLE BOOK	SERIES	QTY
345.11.H.7	CLICK ARMCHAIR 76 METAL ARM	GLOW 0733	NEGRO TEXT.	GLOW KVADRAT	7	1
305.71	TORTUGA TABLE D41X45	-	002-NATURAL	-	-	1
345.11.H.7	CLICK ARMCHAIR 76 METAL ARM	PECTO 0934	NEGRO TEXT.	PECTO FEBRIK KVADRAT	9	1

salones.

Gracias a las voluminosas almohadas que conforman respaldos y brazos, su diseño resulta de lo más atrayente. Sin embargo, lo más destacable de **Click** es sin duda el hecho de ser el primer sofá **“flat-pack”** de **Sancal**. Esta singular característica contribuye a reducir el impacto ambiental de su transporte porque los cúbicos se reducen considerablemente. En cuanto al montaje, haciendo honor a su nombre, es tan fácil como hacer **“click”**.

El amplio abanico de textiles y pieles disponible, junto a la posibilidad de añadir un kit eléctrico, ponen la guinda final.

back and arm cushions. No one could imagine that this is **Sancal's** first **“flat-pack”** sofa. This remarkable feature reduces the environmental impact from transport due to the packaging reduced sizes. Its easy assembling system, as its name suggests is as simple as clicking the elements together.

The wide range of textiles and leather available, together with the possibility of adding electrical sockets, makes this model very interesting for a wide range of projects.

# ROLL

ROLL by Mut

*Trampantojo industrial.  
Industrial "trompe l'oeil".*

[✕](#)

REFERENCE	DESCRIPTION	UPHOLSTERY OR TOP/BASE	FINISH OR NET	SAMPLE BOOK	SERIES	QTY
349.46.J	ROLL SILLA	HUSK 0734	138-ALPINO	HUSK FEBRIK KVADRAT	8	1

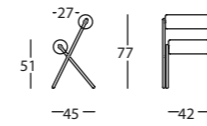



104

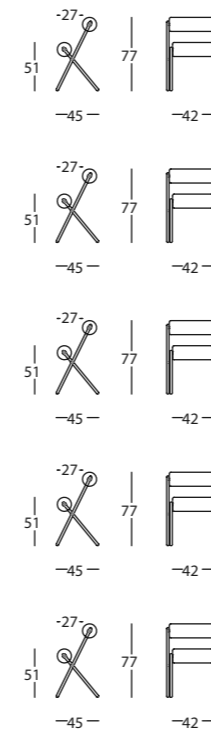

REFERENCE	DESCRIPTION	UPHOLSTERY OR TOP/BASE	FINISH OR NET	SAMPLE BOOK	SERIES	QTY
349.46.J	ROLL CHAIR	CHESTNUT 805	141-NUDE	CLASSIC 2	12	1
349.46.J	ROLL SILLA	5020	141-NUDE	128	5	1
349.46.J	ROLL SILLA	6122	141-NUDE	115	6	1
349.46.J	ROLL SILLA	GLOW 0923	041-MALAQUITA	GLOW KVADRAT	7	1
349.46.J	ROLL SILLA	GALAXY 0298	141-NUDE	GALAXY KVADRAT	7	1



105



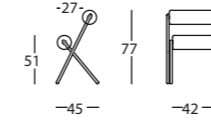
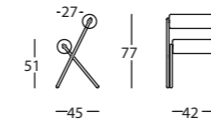
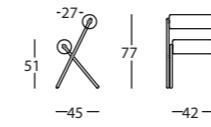
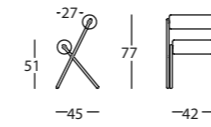
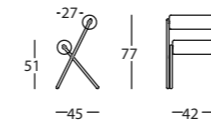
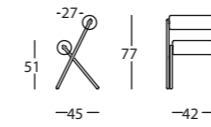
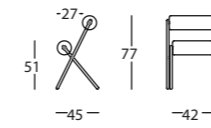
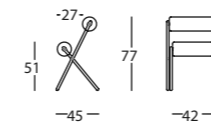
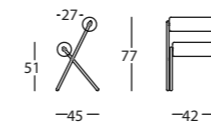
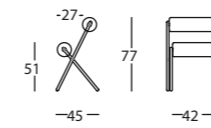

REFERENCE	DESCRIPTION	UPHOLSTERY OR TOP/BASE	FINISH OR NET	SAMPLE BOOK	SERIES	QTY
349.46.J	ROLL SILLA	PLECTO 0624	095-GRIS SEDA	PLECTO FEBRIK KVADRAT	9	2
349.46.J	ROLL SILLA	GLOW 0343	141-NUDE	GLOW KVADRAT	7	2
349.46.J	ROLL SILLA	HUSK 0734	138-ALPINO	HUSK FEBRIK KVADRAT	8	2
349.46.J	ROLL CHAIR	2806	124-CHAMPAN	118	3	2
349.46.J	ROLL SILLA	GALAXY 0298	141-NUDE	GALAXY KVADRAT	7	1
349.46.J	ROLL SILLA	CHESTNUT 805	141-NUDE	CLASSIC 2	12	2
349.46.J	ROLL SILLA	GLOW 0923	041-MALAQUITA	GLOW KVADRAT	7	1
349.46.J	ROLL SILLA	5020	141-NUDE	128	5	1
349.46.J	ROLL CHAIR	6253	141-NUDE	126	6	1
349.46.J	ROLL SILLA	CHESTNUT 805	001-NEGRO	CLASSIC 2	12	1



ROLL by Mut

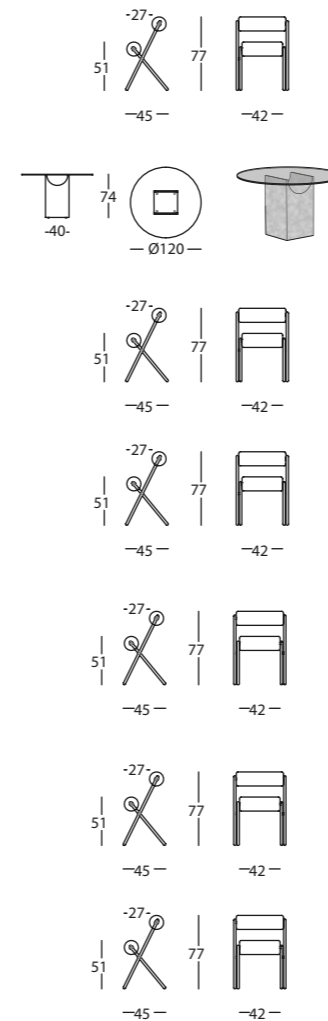

REFERENCE	DESCRIPTION	UPHOLSTERY OR TOP/BASE	FINISH OR NET	SAMPLE BOOK	SERIES	QTY
349.46.J	ROLL SILLA	GLOW 0923	041-MALAQUITA	GLOW KVADRAT	7	1
355.74.NH.CI	VESTIGE TABLE D120X74	GLASS/IQ SURFACE	171-MARINO	-	-	1
349.46.J	ROLL CHAIR	6253	141-NUDE	126	6	1
349.46.J	ROLL SILLA	CHESTNUT 805	141-NUDE	CLASSIC 2	12	2
349.46.J	ROLL SILLA	GALAXY 0298	141-NUDE	GALAXY KVADRAT	7	1
349.46.J	ROLL SILLA	CHESTNUT 805	140-PISCINA	CLASSIC 2	12	2
349.46.J	ROLL SILLA	CHESTNUT 805	001-NEGRO	CLASSIC 2	12	2

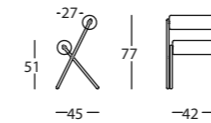

REFERENCE	DESCRIPTION	UPHOLSTERY OR TOP/BASE	FINISH OR NET	SAMPLE BOOK	SERIES	QTY
349.46.J	ROLL SILLA	HUSK 0734	138-ALPINO	HUSK FEBRIK KVADRAT	8	1

Despojada de adornos y elementos superfluos, los creativos valencianos reducen la forma convencional de una silla a dos elementos puros: tubos de acero y dos almohadas cilíndricas para respaldo y asiento. La pasión por la belleza de las cosas simples y las geometrías curvas son sellos distintivos de **Mut** presentes también en este nuevo diseño para Sancal.

Su atípica silueta, completamente alejada del arquetipo, y el juego visual de los cilindros ensalza un objeto cotidiano e industrial y le aporta un cariz artístico que se hace todavía más evidente cuando, al apilar varias unidades, creamos una especie de conjunto escultórico. De este modo, **Roll** aúna equilibrio, belleza y funcionalidad.

La escueta lista de materiales usadas no limita sus posibilidades de personalización, pues sus "rodillos" pueden ser tapizados en cualquier tejido de nuestra carta y combinarse con los 16 lacados disponibles para su estructura de acero. Por otra parte, dicha racionalización de materias primas la hace más sostenible y simplifica su proceso de reciclaje una vez haya terminado su vida útil; la cual prevemos será muy larga porque **Roll** está concebida para perdurar, tanto por su icónico y atemporal diseño como por su calidad.

the conventional shape of a chair to two pure elements: steel tubes and two cylindrical pads for the back and seat. Their passion for the inner charm of simple things and the rounded figures are part of **Mut's** hallmarks, and they are also present in their new design for **Sancal**.

Its unusual silhouette turns an industrial object into a work of art, extenuated still further if stacked into a sculptural figure. In this way, **Roll** combines balance, beauty and functionality.

The reduced number of materials used to manufacture the chair does not limit the possibilities for personalization; the cushions can be upholstered in any of Sancal's fabrics and the metal structure is available in 16 lacquer colours. Moreover, the rationalization of raw materials makes it more sustainable and simplifies the recycling process once its useful life has ended; although we anticipate it will be very long as **Roll** is designed to last, both for its timeless design and its quality.



# MUJERES X MUJERES

Estudio Sancal ha comisariado la exposición temática **Mujeres x Mujeres**. Para ello ha contado con la colaboración de 5 mujeres artistas, las cuales han retratado diversas formas de ser mujer y reivindicar cualidades femeninas más contemporáneas: libres, poderosas, creativas, independientes, reflexivas, amigas, expertas y por qué no, también mujeres extraterrestres e, incluso, inmortales. Las 10 ilustraciones han sido reproducidas en pequeñas series de 50 unidades **Fine Art**, numeradas y firmadas por las autoras.

*Estas reproducciones se pueden adquirir a través de nuestra línea de complementos **Cosas**.*

Estudio Sancal has curated a themed exhibition about Women in life. 5 female artists have portrayed different ways of being a woman from a more contemporary attitude, inviting us to contemplate powerful, extra-terrestrial, creative, immortal, expert, happy, friendly, free, thoughtful and serene women. Each of the 10 illustrations have been reproduced in small series of 50 **Fine Art** copies, **numbered** and **signed** by the authors.

*Art prints can be purchased through **Cosas**, our range of lifestyle products.*

Hahnemühle paper 200 gr  
Fine Art Giclée Printing  
42x60 cm

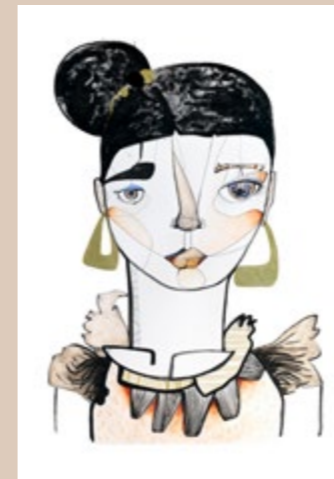

Reflexiva  
Elekna

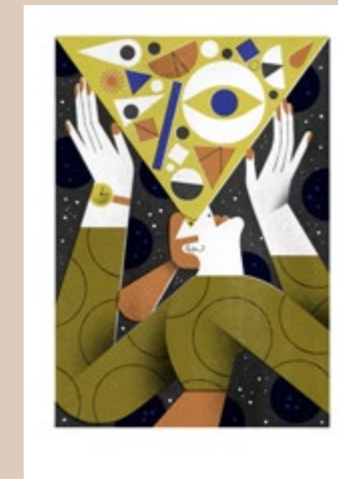

Creativa  
Malota

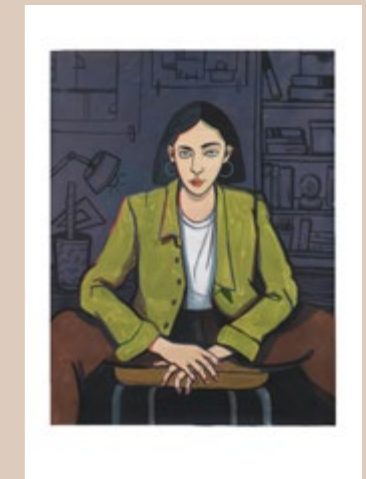

Experta  
Carla Fuentes



Libres  
Clara Iris

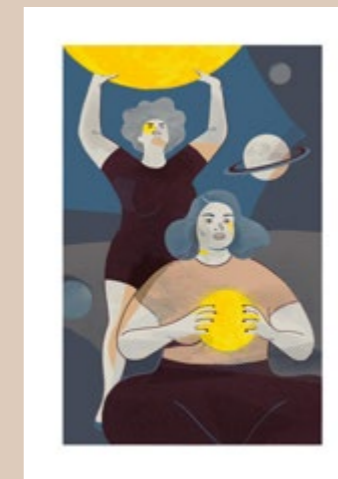

Poderosas  
Ana Galvañ

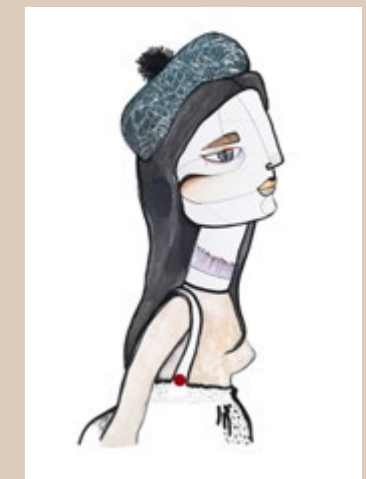

Independiente  
Elekna

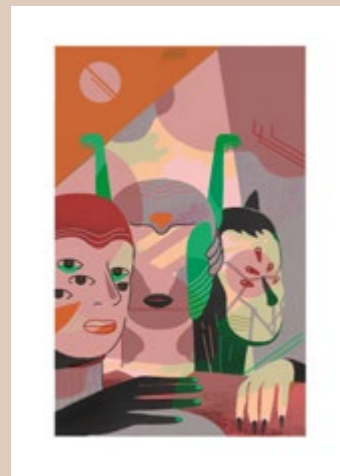

Extraterrestres  
Ana Galvañ

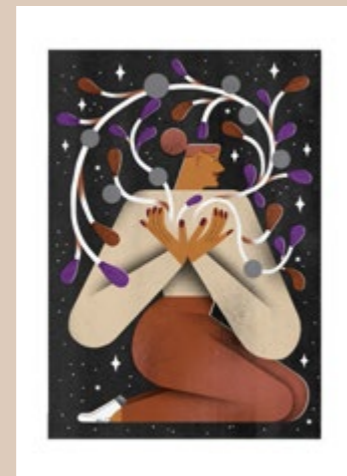

Inmortal  
Malota



Amigas  
Clara Iris



Felices  
Carla Fuentes

index

# TECH- NICAL INDEX

index

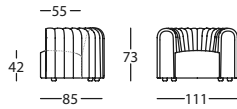

PAGES	REFERENCE	DESCRIPTION	UPHOLSTERY OR TOP/BASE	FINISH OR NET	SAMPLE BOOK	SERIES	QTY
-------	-----------	-------------	------------------------	---------------	-------------	--------	-----

8-9	356.11.N	CORE ARMCHAIR	FACET 53	-	107.2	4	1
-----	----------	---------------	----------	---	-------	---	---

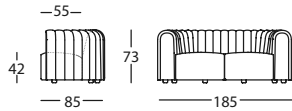

8-9	356.11.U	CORE 185 SOFA	GLOW 0923	-	GLOW KVADRAT	7	1
-----	----------	---------------	-----------	---	--------------	---	---

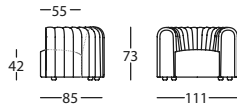

10-11	356.11.N	CORE ARMCHAIR	FACET 1001	-	107.2	4	1
-------	----------	---------------	------------	---	-------	---	---

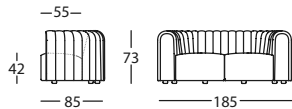

10-11	356.11.U	CORE 185 SOFA	GALAXY 0108	-	GALAXY KVADRAT	7	1
-------	----------	---------------	-------------	---	----------------	---	---

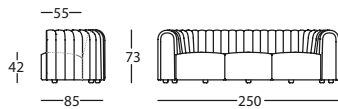

10-11	356.11.Z1	CORE 250 SOFA	7210	-	127	7	1
-------	-----------	---------------	------	---	-----	---	---

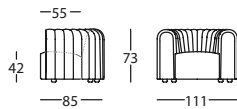

10-11	356.11.N	CORE ARMCHAIR	FACET 53	-	107.2	4	1
-------	----------	---------------	----------	---	-------	---	---

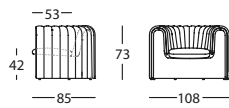

12-13	347.11.N	REMNANT ARMCHAIR	GALAXY 0108	-	GALAXY KVADRAT	7	1
-------	----------	------------------	-------------	---	----------------	---	---

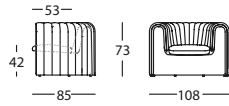

12-13	347.11.N	REMNANT ARMCHAIR	5032	-	128	5	1
-------	----------	------------------	------	---	-----	---	---

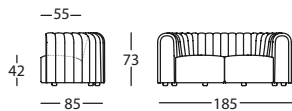

12-13	356.11.U	CORE 185 SOFA	GALAXY 0108	-	GALAXY KVADRAT	7	1
-------	----------	---------------	-------------	---	----------------	---	---

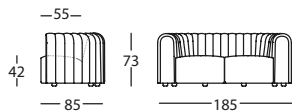

12-13	356.11.U	CORE 185 SOFA	5031	-	128	5	1
-------	----------	---------------	------	---	-----	---	---

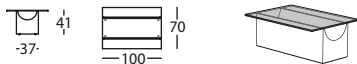

12-13	355.74.LHE	VESTIGE OCCASIONAL TABLE 100X70X41	GLASS/ STAINED ASH	049-GRIS SEDA	-	-	1
-------	------------	------------------------------------	--------------------	---------------	---	---	---

# index

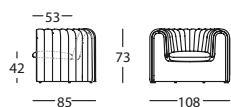

PAGES	REFERENCE	DESCRIPTION	UPHOLSTERY OR TOP/BASE	FINISH OR NET	SAMPLE BOOK	SERIES	QTY
-------	-----------	-------------	------------------------	---------------	-------------	--------	-----

12-13	347.11.N	REMNANT ARMCHAIR	PLANUM 0411	-	PLANUM FEBRIK KVADRAT	8	1
-------	----------	------------------	-------------	---	-----------------------	---	---

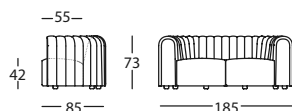

14-15	356.11.U	CORE 185 SOFA	GLOW 0923	-	GLOW KVADRAT	7	1
-------	----------	---------------	-----------	---	--------------	---	---

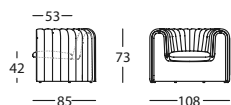

16-17	347.11.N	REMNANT ARMCHAIR	7212	-	127	7	1
-------	----------	------------------	------	---	-----	---	---

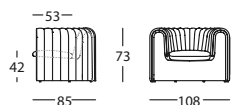

18-19	347.11.N	REMNANT ARMCHAIR	7212	-	127	7	1
-------	----------	------------------	------	---	-----	---	---

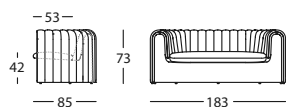

18-19	347.11.U	REMNANT SOFA	PLANUM 0351	-	PLANUM FEBRIK KVADRAT	8	1
-------	----------	--------------	-------------	---	-----------------------	---	---

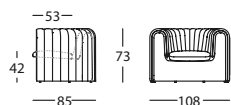

18-19	347.11.N	REMNANT ARMCHAIR	PLANUM 0351	-	PLANUM FEBRIK KVADRAT	8	1
-------	----------	------------------	-------------	---	-----------------------	---	---

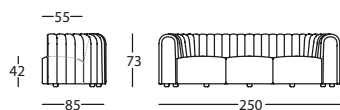

20-21	356.11.Z1	CORE 250 SOFA	7210	-	127	7	1
-------	-----------	---------------	------	---	-----	---	---

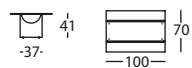

20-21	355.74.LHE	VESTIGE OCCASIONAL TABLE 100X70X41	GLASS/ STAINED ASH	009-CEREZO	-	-	1
-------	------------	------------------------------------	--------------------	------------	---	---	---

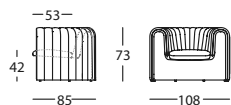

20-21	347.11.N	REMNANT ARMCHAIR	5032	-	128	5	1
-------	----------	------------------	------	---	-----	---	---

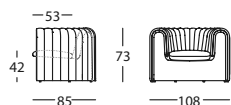

20-21	347.11.N	REMNANT ARMCHAIR	PLANUM 0351	-	PLANUM FEBRIK KVADRAT	8	1
-------	----------	------------------	-------------	---	-----------------------	---	---

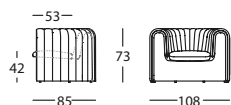

22-23	347.11.N	REMNANT ARMCHAIR	PLANUM 0411	-	PLANUM FEBRIK KVADRAT	8	1
-------	----------	------------------	-------------	---	-----------------------	---	---

index

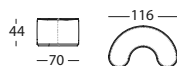
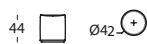
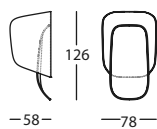
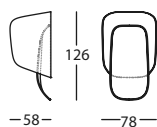
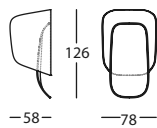
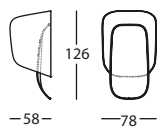
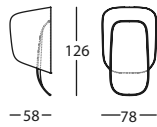
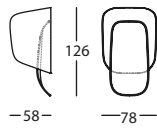
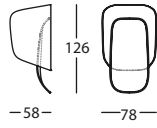
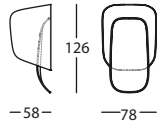
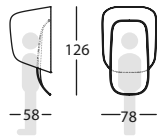

PAGES	REFERENCE	DESCRIPTION	UPHOLSTERY OR TOP/BASE	FINISH OR NET	SAMPLE BOOK	SERIES	QTY
24-25	343.3FA.H	LAPSO HAMACA VERTICAL	CURA 65105	AZUL	CURA GABRIEL	-	1
24-25	343.3FA.H	LAPSO HAMACA VERTICAL	RAZZLE DAZZLE GINGER 0466	AZUL	RAZZLE DAZZLE FEBRIK KVADRAT	-	1
26-27	343.3FA.H	LAPSO HAMACA VERTICAL	SPRINKLES BLUEBIRD 0754	AMARILLO	SPRINKLES FEBRIK KVADRAT	-	1
26-27	343.3FA.H	LAPSO HAMACA VERTICAL	CURA 62082	AMARILLO	CURA GABRIEL	-	1
26-27	343.3FA.H	LAPSO HAMACA VERTICAL	SPRINKLES DUCK 0254	GRIS	SPRINKLES FEBRIK KVADRAT	-	1
26-27	343.3FA.H	LAPSO HAMACA VERTICAL	CURA 65105	AZUL	CURA GABRIEL	-	1
26-27	343.3FA.H	LAPSO HAMACA VERTICAL	CURA 60112	AMARILLO	CURA GABRIEL	-	1
28-29	343.3FA.H	LAPSO HAMACA VERTICAL	SPRINKLES DUCK 0254	GRIS	SPRINKLES FEBRIK KVADRAT	-	2
28-29	343.3FA.H	LAPSO HAMACA VERTICAL	RAZZLE DAZZLE NATURAL 0116	NEGRO	RAZZLE DAZZLE FEBRIK KVADRAT	-	1
28-29	354.15.EE	DIVIDUALS POUF D42X40	6112	049-GRIS SEDA	115	6	1
28-29	354.15.MHE	DIVIDUAL SHAPED POUF 116X70X40	HUSK 0154	049-GRIS SEDA	HUSK FEBRIK KVADRAT	8	1

# index

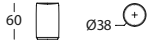
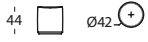
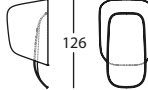
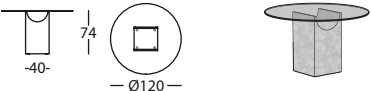
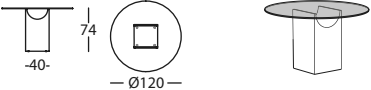
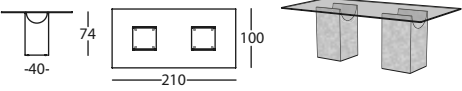
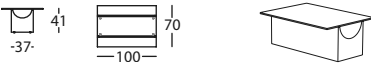
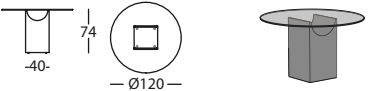
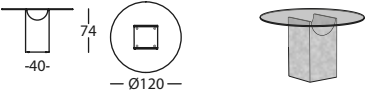
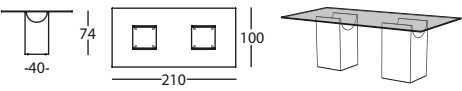
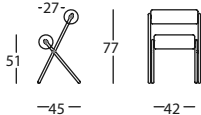
PAGES	REFERENCE	DESCRIPTION	UPHOLSTERY OR TOP/BASE	FINISH OR NET	SAMPLE BOOK	SERIES	QTY	
	28-29	354.15.DG	DIVIDUALS POUF D38X60	HUSK 0554	009-CEREZO	HUSK FEBRIK KVADRAT	8	1
	28-29	354.15.EE	DIVIDUALS POUF D42X40	HUSK 0154	049-GRIS SEDA	HUSK FEBRIK KVADRAT	8	1
	30-31	343.3FA.H	LAPSO HAMACA VERTICAL	SPRINKLES DUCK 0254	GRIS	SPRINKLES FEBRIK KVADRAT	-	2
	32-33	355.74.NH.CI	VESTIGE TABLE D120X74	GLASS/IQ SURFACE	171-MARINO	-	-	1
	34-35	355.74. NH.CT	VESTIGE TABLE D120X74	GLASS/ STAINED ASH	002-NATURAL	-	-	1
	34-35	355.74. XLH.CI	VESTIGE TABLE 210X100X74	GLASS/IQ SURFACE	171-MARINO	-	-	1
	34-35	355.74. LHE.CT	VESTIGE OCCASIONAL TABLE 100X70X41	STAINED ASH	049-GRIS SEDA	-	-	1
	34-35	355.74. NH.CL	VESTIGE TABLE D120X74	GLASS/LAQUER	141-NUDE	-	-	1
	34-35	355.74.NH.CI	VESTIGE TABLE D120X74	GLASS/IQ SURFACE	171-MARINO	-	-	1
	36-37	355.74. XLH.CT	VESTIGE TABLE 210X100X74	GLASS/ STAINED ASH	003-NOGAL	-	-	1
	36-37	349.46.J	ROLL CHAIR	CHESTNUT 805	141-NUDE	CLASSIC 2	12	1

# index

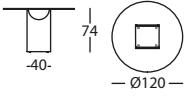
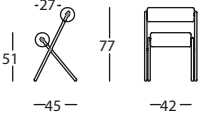
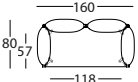
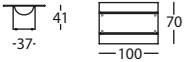
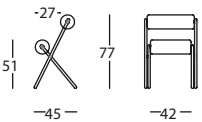
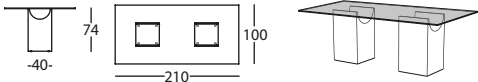
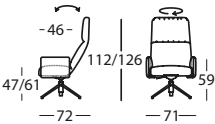
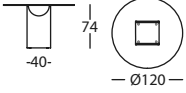
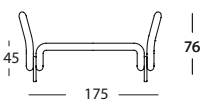
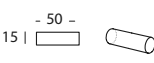
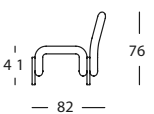
PAGES	REFERENCE	DESCRIPTION	UPHOLSTERY OR TOP/BASE	FINISH OR NET	SAMPLE BOOK	SERIES	QTY	
	36-37	355.74.NH.CT	VESTIGE TABLE D120X74	GLASS/ STAINED ASH	002-NATURAL	-	-	1
	36-37	349.46.J	ROLL CHAIR	2806	124-CHAMPAN	118	3	2
	38-39	345.11.R.4	CLICK SOFA 160	GLOW 0343	NEGRO TEXT.	GLOW KVADRAT	7	1
	38-39	355.74.LHE	VESTIGE OCCASIONAL TABLE 100X70X41	GLASS/IQ SURFACE	171-MARINO	-	-	1
	38-39	349.46.J	ROLL CHAIR	6253	141-NUDE	126	6	1
	38-39	355.74.XLH.CT	VESTIGE TABLE 210X100X74	GLASS/ STAINED ASH	003-NOGAL	-	-	1
	38-39	348.65.4	ELLE EXEC. CHAIR 4 STAR BASE W/ UPH. ARMS	PLANUM 0351	001-BLACK	PLANUM FEBRIK KVADRAT	8	1
	40-41	355.74.NH.CI	VESTIGE TABLE D120X74	GLASS/IQ SURFACE	171-MARINO	-	-	1
	42-43	346.10.S.BR	DIWAN BENCH 175 WITH ARMS	MOSAIC 2 0472	057-CALABAZA	MOSAIC 2 FEBRIK KVADRAT	11	1
	42-43	100.22.FB	CYLINDER CUSHION 50X15	MOSAIC 2 0472	-	MOSAIC 2 FEBRIK KVADRAT	11	2
	44-45	346.12.H	DIWAN LOUNGE CHAIR	PECTO 0654	041-MALAQUITA	PECTO FEBRIK KVADRAT	9	1

# index

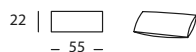

PAGES	REFERENCE	DESCRIPTION	UPHOLSTERY OR TOP/BASE	FINISH OR NET	SAMPLE BOOK	SERIES	QTY
-------	-----------	-------------	------------------------	---------------	-------------	--------	-----

44-45	346.27.FC	DIWAN LUMBAR CUSHION 55X22	CURA 68184	-	CURA GABRIEL	5	1
-------	-----------	----------------------------	------------	---	--------------	---	---

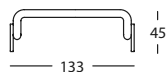

44-45	346.10.Q	DIWAN BENCH 140	CURA 61168	108-NEGRO	CURA GABRIEL	5	2
-------	----------	-----------------	------------	-----------	--------------	---	---

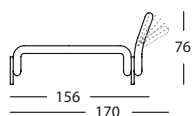

44-45	346.14.H.R	DIWAN CHAISE LONGUE RECLINING BACK	HUSK 0974	002-NATURAL	HUSK FEBRIK KVADRAT	8	1
-------	------------	------------------------------------	-----------	-------------	---------------------	---	---

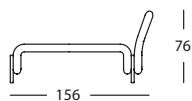

46-47	346.14.H	DIWAN CHAISE LONGUE FIXED BACK	HUSK 0554	009-CEREZO	HUSK FEBRIK KVADRAT	8	1
-------	----------	--------------------------------	-----------	------------	---------------------	---	---

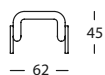

46-47	346.10.G	DIWAN BENCH 62	ATLAS 0671	043-MANGO	ATLAS KVADRAT	6	1
-------	----------	----------------	------------	-----------	---------------	---	---

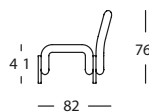

46-47	346.12.H	DIWAN LOUNGE CHAIR	HUSK 0454	002-NATURAL	HUSK FEBRIK KVADRAT	8	2
-------	----------	--------------------	-----------	-------------	---------------------	---	---

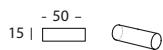

46-47	100.22.FB	CYLINDER CUSHION 50X15	NABUK 27	-	NABUK	12	1
-------	-----------	------------------------	----------	---	-------	----	---

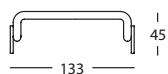

46-47	346.10.Q	DIWAN BENCH 140	CURA 61168	108-NEGRO	CURA GABRIEL	5	2
-------	----------	-----------------	------------	-----------	--------------	---	---

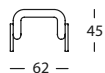

46-47	346.10.G	DIWAN BENCH 62	HUSK 154	108-NEGRO	HUSK FEBRIK KVADRAT	8	1
-------	----------	----------------	----------	-----------	---------------------	---	---

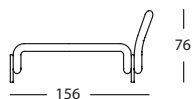

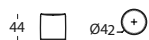

46-47	346.14.H	DIWAN CHAISE LONGUE FIXED BACK	HUSK 734	002-NATURAL	HUSK FEBRIK KVADRAT	8	1
-------	----------	--------------------------------	----------	-------------	---------------------	---	---



48-49	354.15.EE	DIVIDUALS POUF D42X40	MOSAIC 2 0472	009-CEREZO	MOSAIC 2 FEBRIK KVADRAT	11	1
-------	-----------	-----------------------	---------------	------------	-------------------------	----	---

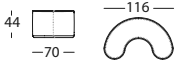
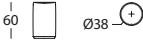
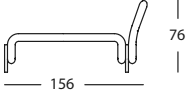

# index

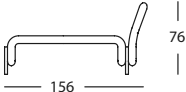
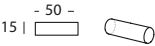
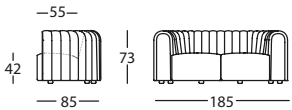
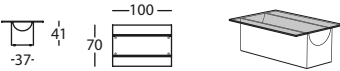
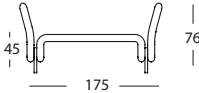
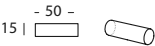
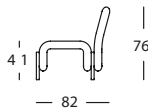
PAGES	REFERENCE	DESCRIPTION	UPHOLSTERY OR TOP/BASE	FINISH OR NET	SAMPLE BOOK	SERIES	QTY	
	48-49	354.15.MHE	DIVIDUAL SHAPED POUF 116X70X40	6119	009-CEREZO	115	6	1
	48-49	354.15.DG	DIVIDUALS POUF D38X60	HUSK 0554	009-CEREZO	HUSK FEBRIK KVADRAT	8	1
	48-49	346.14.H	DIWAN CHAISE LONGUE FIXED BACK	HUSK 0734	002-NATURAL	HUSK FEBRIK KVADRAT	8	1
	48-49	305.71	TORTUGA TABLE D41X45	-	002-NATURAL	-	-	1
	48-49	346.14.H	DIWAN CHAISE LONGUE FIXED BACK	HUSK 0554	009-CEREZO	HUSK FEBRIK KVADRAT	8	1
	48-49	100.22.FB	CYLINDER CUSHION 50X15	NABUK 27	-	NABUK	12	1
	50-51	356.11.U	CORE 185 SOFA	GALAXY 0108	-	GALAXY KVADRAT	7	1
	50-51	355.74.LHE	VESTIGE OCCASIONAL TABLE 100X70X41	GLASS/ STAINED ASH	049-GRIS SEDA	-	1	1
	50-51	346.10.S.BR	DIWAN BENCH 175 WITH ARMS	MOSAIC 2 0472	057-CALABAZA	MOSAIC 2 FEBRIK KVADRAT	11	1
	50-51	100.22.FB	CYLINDER CUSHION 50X15	MOSAIC 2 0472	-	MOSAIC 2 FEBRIK KVADRAT	11	2
	50-51	346.12.H	DIWAN LOUNGE CHAIR	PECTO 0654	041-MALAQUITA	PECTO FEBRIK KVADRAT	9	1

# index

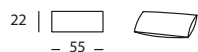

PAGES	REFERENCE	DESCRIPTION	UPHOLSTERY OR TOP/BASE	FINISH OR NET	SAMPLE BOOK	SERIES	QTY
-------	-----------	-------------	------------------------	---------------	-------------	--------	-----

50-51	346.27.FC	DIWAN LUMBAR CUSHION 55X22	8070	-	116	7	1
-------	-----------	----------------------------	------	---	-----	---	---

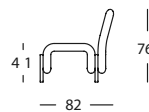

50-51	346.12.H	DIWAN LOUNGE CHAIR	GALAXY 0348	052-KLEIN	GALAXY KVADRAT	7	2
-------	----------	--------------------	-------------	-----------	----------------	---	---

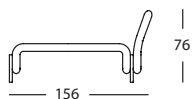

52-53	346.14.H	DIWAN CHAISE LONGUE FIXED BACK	HUSK 0554	009-CEREZO	HUSK FEBRIK KVADRAT	8	1
-------	----------	--------------------------------	-----------	------------	---------------------	---	---

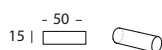

52-53	100.22.FB	CYLINDER CUSHION 50X15	NABUK 27	-	NABUK	12	1
-------	-----------	------------------------	----------	---	-------	----	---



54-55	354.157.DG	DIVIDUALS POUF D38X60 ROTARY	MOSAIC 2 0772	052-KLEIN	MOSAIC 2 FEBRIK KVADRAT	11	1
-------	------------	------------------------------	---------------	-----------	-------------------------	----	---

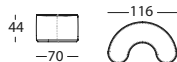

54-55	354.15.MHE	DIVIDUAL SHAPED POUF 116X70X40	GLOW 0343	009-CEREZO	GLOW KVADRAT	7	1
-------	------------	--------------------------------	-----------	------------	--------------	---	---

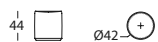

54-55	354.15.EE	DIVIDUALS POUF D42X40	HUSK 0734	009-CEREZO	HUSK FEBRIK KVADRAT	8	1
-------	-----------	-----------------------	-----------	------------	---------------------	---	---



56-57	354.157.DG	DIVIDUALS POUF D38X60 ROTARY	PLECTO 0984	059-MENTA	PLECTO FEBRIK KVADRAT	9	1
-------	------------	------------------------------	-------------	-----------	-----------------------	---	---

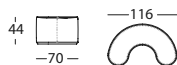

56-57	354.15.MHE	DIVIDUAL SHAPED POUF 116X70X40	6252	009-CEREZO	126	6	1
-------	------------	--------------------------------	------	------------	-----	---	---

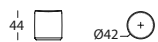

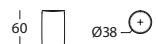

56-57	354.15.EE	DIVIDUALS POUF D42X40	ATLAS 0561	003-NOGAL	ATLAS KVADRAT	6	1
-------	-----------	-----------------------	------------	-----------	---------------	---	---





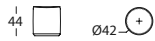
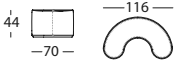
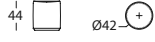

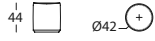
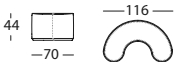
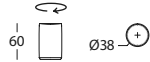
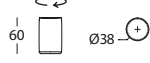
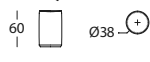
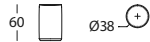
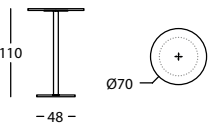
56-57	354.15.DG	DIVIDUALS POUF D38X60	HUSK 0554	009-CEREZO	HUSK FEBRIK KVADRAT	8	1
-------	-----------	-----------------------	-----------	------------	---------------------	---	---

index

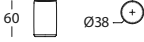
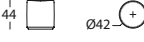
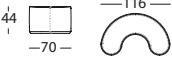
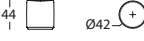
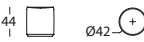
	PAGES	REFERENCE	DESCRIPTION	UPHOLSTERY OR TOP/BASE	FINISH OR NET	SAMPLE BOOK	SERIES	QTY
	56-57	354.15.EE	DIVIDUALS POUF D42X40	HUSK 0734	009-CEREZO	HUSK FEBRIK KVADRAT	8	1
	56-57	354.15.MHE	DIVIDUAL SHAPED POUF 116X70X40	CHESTNUT 805	009-CEREZO	CLASSIC 2	12	1
	56-57	354.15.EE	DIVIDUALS POUF D42X40	5003	009-CEREZO	122	5	1
	56-57	354.15.DG	DIVIDUALS POUF D38X60	GALAXY 0408	049-GRIS SEDA	GALAXY KVADRAT	7	1
	56-57	354.15.EE	DIVIDUALS POUF D42X40	6112	049-GRIS SEDA	115	6	1
	56-57	354.15.MHE	DIVIDUAL SHAPED POUF 116X70X40	HUSK 0154	049-GRIS SEDA	HUSK FEBRIK KVADRAT	8	1
	58-59	354.157.DG	DIVIDUALS POUF D38X60 ROTARY	HUSK 0454	003-NOGAL	HUSK FEBRIK KVADRAT	8	1
	58-59	354.157.DG	DIVIDUALS POUF D38X60 ROTARY	GALAXY 0408	049-GRIS SEDA	GALAXY KVADRAT	7	1
	58-59	354.157.DG	DIVIDUALS POUF D38X60 ROTARY	PECTO 0984	059-MENTA	PECTO FEBRIK KVADRAT	9	1
	58-59	354.15.DG	DIVIDUALS POUF D38X60	5020	049-GRIS SEDA	128	5	1
	58-59	318.79. D70X110	DUMBBELL TABLE D70X110	-	POLYREY ROC BRIQUE/127-BRIQUE		-	1

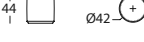
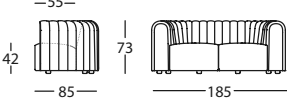
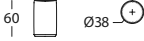
index

	PAGES	REFERENCE	DESCRIPTION	UPHOLSTERY OR TOP/BASE	FINISH OR NET	SAMPLE BOOK	SERIES	QTY
	58-59	354.15.DG	DIVIDUALS POUF D38X60	HUSK 0554	009-CEREZO	HUSK FEBRIK KVADRAT	8	1
	58-59	354.15.EE	DIVIDUALS POUF D42X40	5003	003-NOGAL	122	5	1
	58-59	354.15.MHE	DIVIDUAL SHAPED POUF 116X70X40	6252	009-CEREZO	126	6	1
	58-59	354.15.EE	DIVIDUALS POUF D42X40	PLATA	003-NOGAL	-	12	1
	60-61	354.15.EE	DIVIDUALS POUF D42X40	HUSK 0154	049-GRIS SEDA	HUSK FEBRIK KVADRAT	8	1
	60-61	354.15.MHE	DIVIDUAL SHAPED POUF 116X70X40	HUSK 0154	049-GRIS SEDA	HUSK FEBRIK KVADRAT	8	1
	60-61	354.15.EE	DIVIDUALS POUF D42X40	PECTO 0934	059-MENTA	PECTO FEBRIK KVADRAT	9	1
	60-61	356.11.U	CORE 185 SOFA	GLOW 0923	-	GLOW KVADRAT	7	1
	60-61	354.15.DG	DIVIDUALS POUF D38X60	5020	049-GRIS SEDA	128	5	1
	60-61	305.71	TORTUGA TABLE D41X45	-	002-NATURAL	-	-	2
	60-61	354.15.DG	DIVIDUALS POUF D38X60	GALAXY 0408	049-GRIS SEDA	GALAXY KVADRAT	7	1

# index

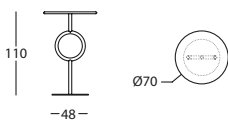
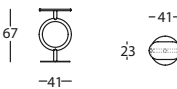
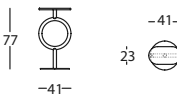
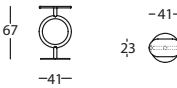
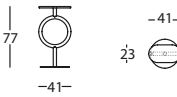
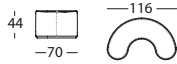
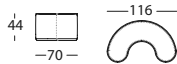
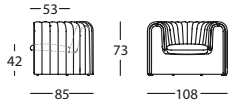
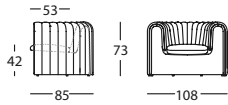

PAGES	REFERENCE	DESCRIPTION	UPHOLSTERY OR TOP/BASE	FINISH OR NET	SAMPLE BOOK	SERIES	QTY
60-61	347.11.N	REMNANT ARMCHAIR	7212	-	127	7	1
60-61	347.11.N	REMNANT ARMCHAIR	GALAXY 0108	-	GALAXY KVADRAT	7	1
60-61	354.15.MHE	DIVIDUAL SHAPED POUF 116X70X40	GLOW 0343	009-CEREZO	GLOW KVADRAT	7	1
60-61	354.15.EE	DIVIDUALS POUF D42X40	6112	049-GRIS SEDA	115	6	1
62-63	354.15.MHE	DIVIDUAL SHAPED POUF 116X70X40	HUSK 0684	009-CEREZO	HUSK FEBRIK KVADRAT	8	1
62-63	354.15.DG	DIVIDUALS POUF D38X60	HUSK 0554	009-CEREZO	HUSK FEBRIK KVADRAT	8	1
64-65	353.46.H	TOTEM STOOL 77	RAZZLE DAZZLE NATURAL 0116	001-NEGRO	RAZZLE DAZZLE FEBRIK KVADRAT	9	1
64-65	353.46.G	TOTEM STOOL 67	RAZZLE DAZZLE NATURAL 0116	001-NEGRO	RAZZLE DAZZLE FEBRIK KVADRAT	9	1
66-67	353.46.H	TOTEM STOOL 77	CHESTNUT 805	139-CASTAÑO	CLASSIC 2	12	1
66-67	353.46.G	TOTEM STOOL 67	CHESTNUT 805	139-CASTAÑO	CLASSIC 2	12	1
66-67	353.71.HM	TOTEM TABLE	057 CALABAZA	139-CASTAÑO			

index

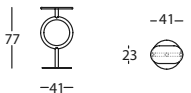
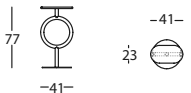
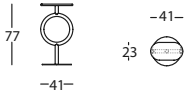
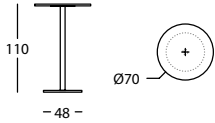
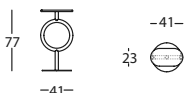
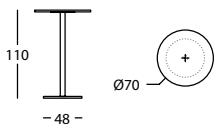
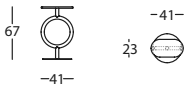
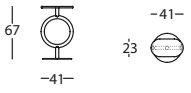
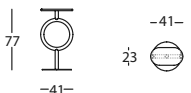
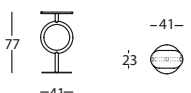
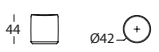
	PAGES	REFERENCE	DESCRIPTION	UPHOLSTERY OR TOP/BASE	FINISH OR NET	SAMPLE BOOK	SERIES	QTY
	66-67	353.46.H	TOTEM STOOL 77	ATLANTIC 61166	124 CHAMPAGE	112	2	1
	68-69	353.46.H	TOTEM STOOL 77	GLOW 0343	141-NUDE	GLOW KVADRAT	7	2
	68-69	353.46.H	TOTEM STOOL 77	CHESTNUT 805	139-CASTAÑO	CLASSIC 2	12	2
	68-69	318.79. D70X110	DUMBBELL TABLE D70X110	-	POLYREY ROC BRIQUE/127- BRIQUE	-	-	1
	68-69	353.46.H	TOTEM STOOL 77	RAZZLE DAZZLE NATURAL 0116	001 NEGRO	RAZZLE DAZZLE FEBRIK KVADRAT	9	2
	68-69	318.79. D70X110	DUMBBELL TABLE D70X110	-	POLYREY ROC NEGRO/001- NOIR	-	-	1
	70-71	353.46.G	TOTEM STOOL 67	HUSK 0684	125-BERENJENA	HUSK FEBRIK KVADRAT	8	1
	70-71	353.46.G	TOTEM STOOL 67	CHESTNUT 805	139-CASTAÑO	CLASSIC 2	12	1
	70-71	353.46.H	TOTEM STOOL 77	ATLANTIC 61166	124 CHAMPAGE	112	2	2
	70-71	353.46.H	TOTEM STOOL 77	HUSK 0684	125-BERENJENA	HUSK FEBRIK KVADRAT	8	1
	70-71	354.15.EE	DIVIDUALS POUF D42X40	ATLAS 0561	003-NOGAL	ATLAS KVADRAT	6	1

index

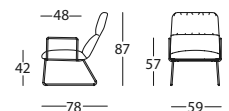
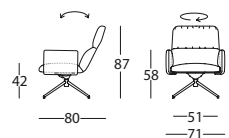
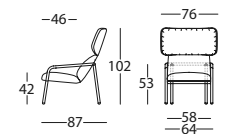
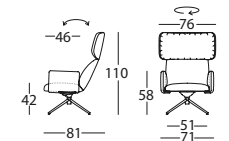
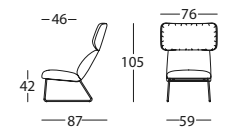
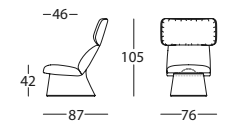
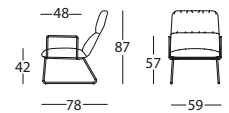
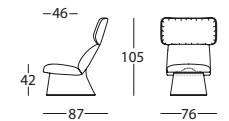
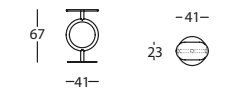
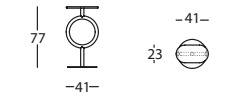
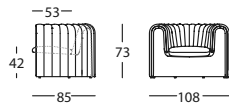

PAGES	REFERENCE	DESCRIPTION	UPHOLSTERY OR TOP/BASE	FINISH OR NET	SAMPLE BOOK	SERIES	QTY
70-71	347.11.N	REMNANT ARMCHAIR	6252	-	126	6	
72-73	353.46.H	TOTEM STOOL 77	CHESTNUT 805	139-CASTAÑO	CLASSIC 2	12	1
72-73	353.46.G	TOTEM STOOL 67	CHESTNUT 805	139-CASTAÑO	CLASSIC 2	12	1
74-75	348.63.T	ELLE WING CHAIR W/ UPHOLSTERED BASE	NABUK 11	-	NABUK	12	1
74-75	348.51.BT7	ELLE LOUNGE CHAIR SLED BASE W/METAL ARMS	NITTO 0427	001-NEGRO	NITTO FEBRIK KVADRAT	7	1
76-77	348.63.T	ELLE WING CHAIR W/ UPHOLSTERED BASE	NABUK 11	-	NABUK	12	1
76-77	348.63.BT	ELLE WING CHAIR SLED BASE	5020	001-NEGRO	128	5	1
76-77	348.65.OJ4	ELLE WING CHAIR 4 STAR BASE W/ UPH. ARMS	5020	001-NEGRO	128	5	1
76-77	348.63.7	ELLE WING CHAIR 4 LEG STRUCT. W/ARMS	SIENA 801	139-CASTAÑO	CLASSIC 2	12	1
76-77	348.55.4	ELLE LOUNGE CHAIR 4 STAR BASE W/ UPH. ARMS	PLANUM 0571	001-NEGRO	PLANUM FEBRIK KVADRAT	8	1
76-77	348.51.BT7	ELLE LOUNGE CHAIR SLED BASE W/METAL ARMS	PLANUM 0571	001-NEGRO	PLANUM FEBRIK KVADRAT	8	1

index

PAGES	REFERENCE	DESCRIPTION	UPHOLSTERY OR TOP/BASE	FINISH OR NET	SAMPLE BOOK	SERIES	QTY	
	76-77	348.55	ELLE LOUNGE CHAIR 4 STAR BASE	PLANUM 0571	001-BLACK	PLANUM FEBRIK KVADRAT	8	1
	76-77	348.51.7	ELLE LOUNGE CHAIR 4 LEG STRUCT. W/ARMS	PLANUM 0741	140-PISCINA	PLANUM FEBRIK KVADRAT	8	1
	78-79	348.65.4	ELLE EXEC. CHAIR 4 STAR BASE W/ UPH. ARMS	PLANUM 0351	001-NEGRO	PLANUM FEBRIK KVADRAT	8	1
	78-79	348.65.7	ELLE EXEC. CHAIR 4 STAR BASE W/ METAL ARMS	PLANUM 0351	001-NEGRO	PLANUM FEBRIK KVADRAT	8	1
	78-79	348.65.9	ELLE EXEC. CHAIR 5 STAR BASE W/WHEELS	MOSAIC 2 0922	001-NEGRO	MOSAIC 2 FEBRIK KVADRAT	11	1
	80-81	348.55	ELLE LOUNGE CHAIR 4 STAR BASE	NITTO 0527	001-NEGRO	NITTO FEBRIK KVADRAT	7	1
	80-81	305.71	TORTUGA TABLE D41X45	-	002-NATURAL	-	-	1
	80-81	348.55	ELLE LOUNGE CHAIR 4 STAR BASE	NITTO 0427	001-NEGRO	NITTO FEBRIK KVADRAT	7	1
	80-81	348.65.7	ELLE EXEC. CHAIR 4 STAR BASE W/ METAL ARMS	MOSAIC 2 0922	001-NEGRO	MOSAIC 2 FEBRIK KVADRAT	11	1
	80-81	355.74. XLH.CI	VESTIGE TABLE 210X100X74	GLASS/IQ SURFACE	171-MARINO	-	-	1
	82-83	348.51.7	ELLE LOUNGE CHAIR 4 LEG STRUCT. W/ARMS	PLANUM 0571	125-BERENJENA	PLANUM FEBRIK KVADRAT	8	1



index



PAGES	REFERENCE	DESCRIPTION	UPHOLSTERY OR TOP/BASE	FINISH OR NET	SAMPLE BOOK	SERIES	QTY
-------	-----------	-------------	------------------------	---------------	-------------	--------	-----

82-83	354.15.EE	DIVIDUALS POUF D42X40	MOSAIC 2 0682	056-ROJO	MOSAIC 2 FEBRIK KVADRAT	11	1
-------	-----------	-----------------------	---------------	----------	-------------------------	----	---

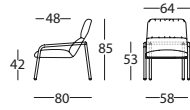

82-83	348.51.7	ELLE LOUNGE CHAIR 4 LEG STRUCT. W/ARMS	PLANUM 0741	140-PISCINA	PLANUM FEBRIK KVADRAT	8	1
-------	----------	--	-------------	-------------	-----------------------	---	---

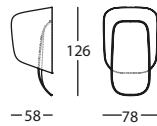

82-83	343.3FA.H	LAPSO HAMACA VERTICAL	SPRINKLES BLUEBIRD 0754	AMARILLO	SPRINKLES FEBRIK KVADRAT	-	1
-------	-----------	-----------------------	-------------------------	----------	--------------------------	---	---

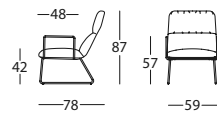

82-83	348.51.BT7	ELLE LOUNGE CHAIR SLED BASE W/METAL ARMS	PLANUM 0741	001-NEGRO	PLANUM FEBRIK KVADRAT	8	1
-------	------------	--	-------------	-----------	-----------------------	---	---



82-83	305.71	TORTUGA TABLE D41X45	-	002-NATURAL	-	-	1
-------	--------	----------------------	---	-------------	---	---	---

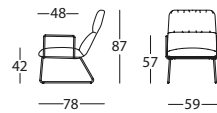

82-83	348.51.BT7	ELLE LOUNGE CHAIR SLED BASE W/METAL ARMS	PLANUM 0571	001-NEGRO	PLANUM FEBRIK KVADRAT	8	1
-------	------------	--	-------------	-----------	-----------------------	---	---

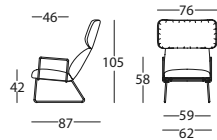

84-85	348.63.BT7	ELLE WING CHAIR SLED BASE W/METAL ARMS	TAUPE 823	138-ALPINO	CLASSIC 2	12	1
-------	------------	--	-----------	------------	-----------	----	---

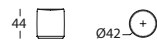

84-85	354.15.EE	DIVIDUALS POUF D42X40	5003	003-NOGAL	122	5	1
-------	-----------	-----------------------	------	-----------	-----	---	---

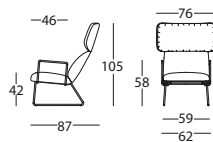

84-85	348.63.BT7	ELLE WING CHAIR SLED BASE W/METAL ARMS	6108	001-NEGRO	114	6	1
-------	------------	--	------	-----------	-----	---	---



84-85	354.157.DG	DIVIDUALS POUF D38X60 ROTARY	5020	049-GRIS SEDA	128	5	1
-------	------------	------------------------------	------	---------------	-----	---	---

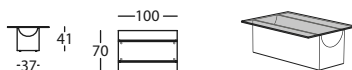

84-85	355.74.LHE	VESTIGE OCCASIONAL TABLE 100X70X41	GLASS/ STAINED ASH	009-CEREZO	-	-	1
-------	------------	------------------------------------	--------------------	------------	---	---	---

index

	PAGES	REFERENCE	DESCRIPTION	UPHOLSTERY OR TOP/BASE	FINISH OR NET	SAMPLE BOOK	SERIES	QTY
	84-85	100.22.FB	CYLINDER CUSHION 50X15	NABUK 27	-	NABUK	12	1
	84-85	356.11.Z1	CORE 250 SOFA	7210	-	127	7	1
	86-87	348.51.BT7	ELLE LOUNGE CHAIR SLED BASE W/METAL ARMS	NITTO 0527	001-NEGRO	NITTO FEBRIK KVADRAT	7	1
	86-87	305.71	TORTUGA TABLE D41X45	-	002-NATURAL	-	-	1
	89-90	345.12.H.4.I	CLICK MODULE 80 LEFT ARM	5004	NEGRO TEXT.	122	5	1
	89-90	345.12.H.4.D	CLICK MODULE 80 RIGHT ARM	5004	NEGRO TEXT.	122	5	1
	89-90	345.22.DC	COJIN	PLECTO 0444	-	PLECTO FEBRIK KVADRAT	9	1
	90-91	345.11.K.4	CLICK ARMCHAIR 90	6122	NEGRO TEXT.	115	6	1
	90-91	345.79.E	CLICK SIDE TABLE 27X39	-	002 NATURAL / NEGRO TEXT.	-	-	2
	90-91	345.15.G	CLICK POUF 69X69	HUSK 0124	NEGRO TEXT.	HUSK FEBRIK KVADRAT	8	2

# index

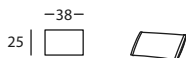
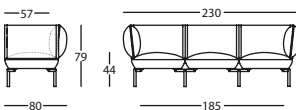
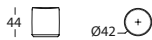
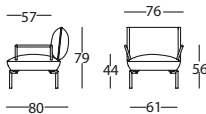
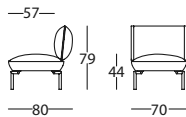
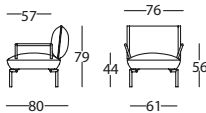
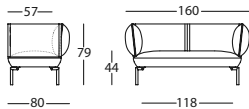
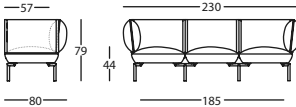
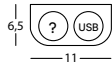
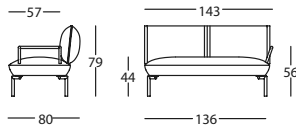

PAGES	REFERENCE	DESCRIPTION	UPHOLSTERY OR TOP/BASE	FINISH OR NET	SAMPLE BOOK	SERIES	QTY
90-91	345.12.Q.7.D	CLICK MODULE 143 RIGHT METAL ARM	HUSK 0124	NEGRO TEXT.	HUSK FEBRIK KVADRAT	8	1
90-91	345.2H.MIX	CLICK ELECTRIC SET 1 PLUG BASE + 1 USB	-	-	-	-	1
92-93	345.11.Z.4	CLICK SOFA 230	GLOW 0543	NEGRO TEXT.	GLOW KVADRAT	7	1
92-93	345.11.R.4	CLICK SOFA 160	GLOW 0343	NEGRO TEXT.	GLOW KVADRAT	7	1
92-93	345.11.H.7	CLICK ARMCHAIR 76 METAL ARM	PECTO 0934	NEGRO TEXT.	PECTO FEBRIK KVADRAT	9	1
92-93	354.12.H	CLICK MODULE 70	HUSK 0734	NEGRO TEXT.	HUSK FEBRIK KVADRAT	8	1
92-93	345.11.H.7	CLICK ARMCHAIR 76 METAL ARM	GLOW 0733	NEGRO TEXT.	GLOW KVADRAT	7	1
94-95	305.71	TORTUGA TABLE D41X45	-	002-NATURAL	-	-	1
94-95	354.15.EE	DIVIDUALS POUF D42X40	MOSAIC 2 0472	009-CEREZO	MOSAIC 2 FEBRIK KVADRAT	11	1
94-95	345.11.Z.4	CLICK SOFA 230	GLOW 0543	NEGRO TEXT.	GLOW KVADRAT	7	1
94-95	345.22.DC	CLICK CUSHION 38X25	PECTO 0444	-	PECTO FEBRIK KVADRAT	9	1

index

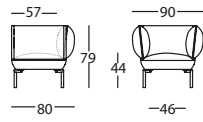

PAGES	REFERENCE	DESCRIPTION	UPHOLSTERY OR TOP/BASE	FINISH OR NET	SAMPLE BOOK	SERIES	QTY
-------	-----------	-------------	------------------------	---------------	-------------	--------	-----

94-95	345.11.K.4	CLICK ARMCHAIR 90	NABUK 27	NEGRO TEXT.	NABUK	12	1
-------	------------	-------------------	----------	-------------	-------	----	---

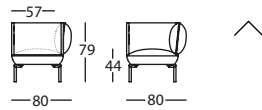

96-97	345.12.H.4.D	CLICK MODULE 80 RIGHT ARM	5004	NEGRO TEXT.	122	5	2
-------	--------------	---------------------------	------	-------------	-----	---	---

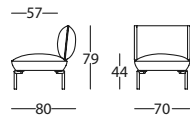

96-97	354.12.H	CLICK MODULE 70	5004	NEGRO TEXT.	122	5	2
-------	----------	-----------------	------	-------------	-----	---	---

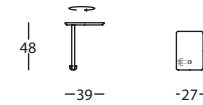

96-97	345.79.E	CLICK SIDE TABLE 27X39	-	002 NATURAL / NEGRO TEXT.	-	-	2
-------	----------	------------------------	---	---------------------------	---	---	---

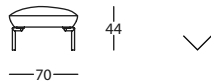

96-97	345.15.G	CLICK POUF 70X70	5004	NEGRO TEXT.	122	5	2
-------	----------	------------------	------	-------------	-----	---	---

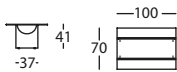

96-97	355.74.LHE	VESTIGE OCCASIONAL TABLE 100X70X41	GLASS / STAINED ASH	058-LAVANDA	-	-	1
-------	------------	------------------------------------	---------------------	-------------	---	---	---

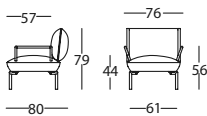

96-97	345.11.H.7	CLICK ARMCHAIR 76 METAL ARM	GLOW 0733	NEGRO TEXT.	GLOW KVADRAT	7	1
-------	------------	-----------------------------	-----------	-------------	--------------	---	---

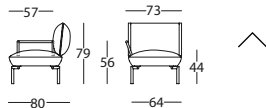

96-97	345.12.H.7.I	CLICK MODULE 73 LEFT METAL ARM	PLECTO 0934	NEGRO TEXT.	PLECTO FEBRIK KVADRAT	9	1
-------	--------------	--------------------------------	-------------	-------------	-----------------------	---	---

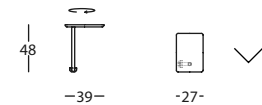

96-97	345.79.E	CLICK SIDE TABLE 27X39	-	001-BLACK / NEGRO TEXT.	-	-	1
-------	----------	------------------------	---	-------------------------	---	---	---

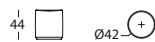

96-97	354.15.EE	DIVIDUALS POUF D42X40	PLECTO 0934	059-MENTA	PLECTO FEBRIK KVADRAT	9	1
-------	-----------	-----------------------	-------------	-----------	-----------------------	---	---

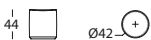

96-97	354.15.EE	DIVIDUALS POUF D42X40	HUSK 0154	049-GRIS SEDA	HUSK FEBRIK KVADRAT	8	1
-------	-----------	-----------------------	-----------	---------------	---------------------	---	---

# index

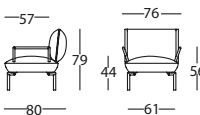
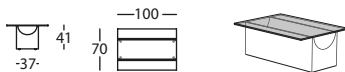
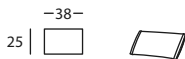
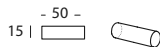
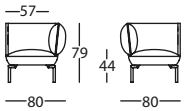
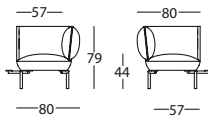
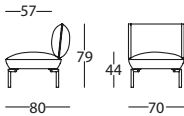
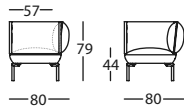
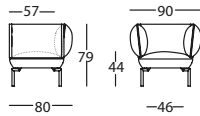
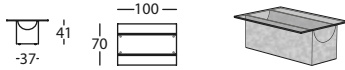
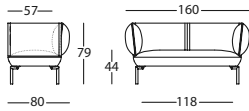

PAGES	REFERENCE	DESCRIPTION	UPHOLSTERY OR TOP/BASE	FINISH OR NET	SAMPLE BOOK	SERIES	QTY
96-97	345.11.R.4	CLICK SOFA 160	GLOW 0343	NEGRO TEXT.	GLOW KVADRAT	7	1
96-97	355.74.LHE	VESTIGE OCCASIONAL TABLE 100X70X41	GLASS/IQ SURFACE	171-MARINO	-	-	1
98-99	345.11.K.4	CLICK ARMCHAIR 90	NABUK 27	NEGRO TEXT.	NABUK	12	1
98-99	345.12.H.4.D	CLICK MODULE 80 RIGHT ARM	5004	NEGRO TEXT.	122	5	1
98-99	354.12.H	CLICK MODULE 70	5004	NEGRO TEXT.	122	5	2
98-99	345.161.H	CLICK RIGHT CORNER 80X80	5004	NEGRO TEXT.	122	5	1
98-99	345.12.H.4.I	CLICK MODULE 80 LEFT ARM	5004	NEGRO TEXT.	122	5	1
98-99	100.22.FB	CYLINDER CUSHION 50X15	NABUK 27	-	NABUK	12	1
98-99	345.22.DC	CLICK CUSHION 38X25	PLECTO 444	-	PLECTO FEBRIK KVADRAT	9	
98-99	355.74.LHE	VESTIGE OCCASIONAL TABLE 100X70X41	GLASS/ STAINED ASH	009-CEREZO	-	-	1
100-101	345.11.H.7	CLICK ARMCHAIR 76 METAL ARM	GLOW 0733	NEGRO TEXT.	GLOW KVADRAT	7	1

index



PAGES	REFERENCE	DESCRIPTION	UPHOLSTERY OR TOP/BASE	FINISH OR NET	SAMPLE BOOK	SERIES	QTY
-------	-----------	-------------	------------------------	---------------	-------------	--------	-----

100-101	305.71	TORTUGA TABLE D41X45	-	002-NATURAL	-	-	1
---------	--------	----------------------	---	-------------	---	---	---

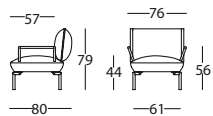

100-101	345.11.H.7	CLICK ARMCHAIR 76 METAL ARM	PLECTO 0934	NEGRO TEXT.	PLECTO FEBRIK KVADRAT	9	1
---------	------------	-----------------------------	-------------	-------------	-----------------------	---	---

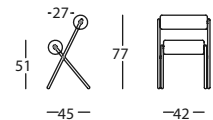

102-103	349.46.J	ROLL SILLA	HUSK 0734	138-ALPINO	HUSK FEBRIK KVADRAT	8	1
---------	----------	------------	-----------	------------	---------------------	---	---

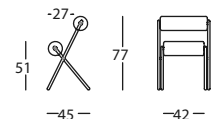

104-105	349.46.J	ROLL CHAIR	CHESTNUT 805	141-NUDE	CLASSIC 2	12	1
---------	----------	------------	--------------	----------	-----------	----	---

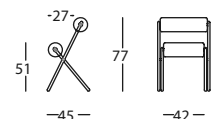

104-105	349.46.J	ROLL SILLA	5020	141-NUDE	128	5	1
---------	----------	------------	------	----------	-----	---	---

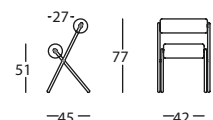

104-105	349.46.J	ROLL SILLA	6122	141-NUDE	115	6	1
---------	----------	------------	------	----------	-----	---	---

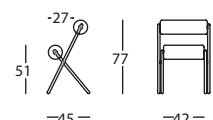

104-105	349.46.J	ROLL SILLA	GLOW 0923	041-MALAQUITA	GLOW KVADRAT	7	1
---------	----------	------------	-----------	---------------	--------------	---	---

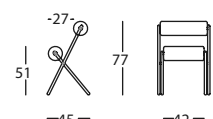

104-105	349.46.J	ROLL SILLA	GALAXY 0298	141-NUDE	GALAXY KVADRAT	7	1
---------	----------	------------	-------------	----------	----------------	---	---

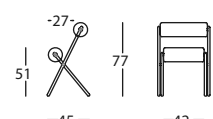

106-107	349.46.J	ROLL SILLA	PLECTO 0624	095-GRIS SEDA	PLECTO FEBRIK KVADRAT	9	2
---------	----------	------------	-------------	---------------	-----------------------	---	---

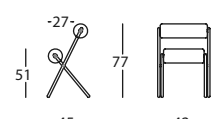

106-107	349.46.J	ROLL SILLA	GLOW 0343	141-NUDE	GLOW KVADRAT	7	2
---------	----------	------------	-----------	----------	--------------	---	---

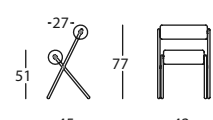

106-107	349.46.J	ROLL SILLA	HUSK 0734	138-ALPINO	HUSK FEBRIK KVADRAT	8	2
---------	----------	------------	-----------	------------	---------------------	---	---

index

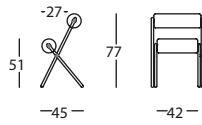

PAGES	REFERENCE	DESCRIPTION	UPHOLSTERY OR TOP/BASE	FINISH OR NET	SAMPLE BOOK	SERIES	QTY
-------	-----------	-------------	------------------------	---------------	-------------	--------	-----

106-107	349.46.J	ROLL CHAIR	2806	124-CHAMPAN	118	3	2
---------	----------	------------	------	-------------	-----	---	---

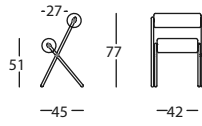

106-107	349.46.J	ROLL SILLA	GALAXY 0298	141-NUDE	GALAXY KVADRAT	7	1
---------	----------	------------	-------------	----------	----------------	---	---

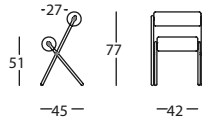

106-107	349.46.J	ROLL SILLA	CHESTNUT 805	141-NUDE	CLASSIC 2	12	2
---------	----------	------------	--------------	----------	-----------	----	---

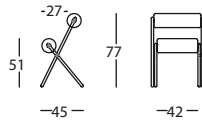

106-107	349.46.J	ROLL SILLA	GLOW 0923	041-MALAQUITA	GLOW KVADRAT	7	1
---------	----------	------------	-----------	---------------	--------------	---	---

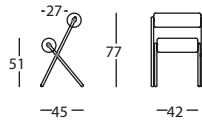

106-107	349.46.J	ROLL SILLA	5020	141-NUDE	128	5	1
---------	----------	------------	------	----------	-----	---	---

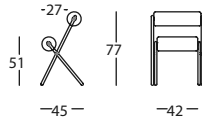

106-107	349.46.J	ROLL CHAIR	6253	141-NUDE	126	6	1
---------	----------	------------	------	----------	-----	---	---

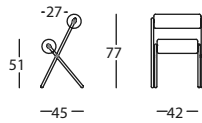

106-107	349.46.J	ROLL SILLA	CHESTNUT 805	001-NEGRO	CLASSIC 2	12	1
---------	----------	------------	--------------	-----------	-----------	----	---

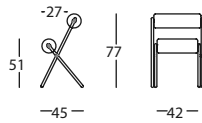

108-109	349.46.J	ROLL SILLA	GLOW 0923	041-MALAQUITA	GLOW KVADRAT	7	1
---------	----------	------------	-----------	---------------	--------------	---	---

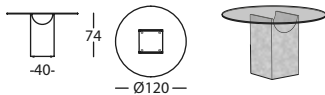

108-109	355.74.NH.CI	VESTIGE TABLE D120X74	GLASS/IQ SURFACE	171-MARINO	-	-	1
---------	--------------	-----------------------	------------------	------------	---	---	---

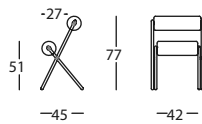

108-109	349.46.J	ROLL CHAIR	6253	141-NUDE	126	6	1
---------	----------	------------	------	----------	-----	---	---

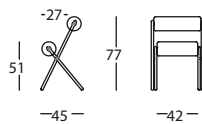

108-109	349.46.J	ROLL SILLA	CHESTNUT 805	141-NUDE	CLASSIC 2	12	2
---------	----------	------------	--------------	----------	-----------	----	---

# index

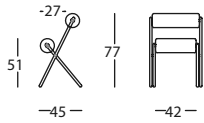
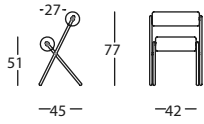
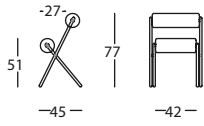
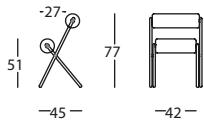

PAGES	REFERENCE	DESCRIPTION	UPHOLSTERY OR TOP/BASE	FINISH OR NET	SAMPLE BOOK	SERIES	QTY
108-109	349.46.J	ROLL SILLA	GALAXY 0298	141-NUDE	GALAXY KVADRAT	7	1
108-109	349.46.J	ROLL SILLA	CHESTNUT 805	140-PISCINA	CLASSIC 2	12	2
108-109	349.46.J	ROLL SILLA	CHESTNUT 805	001-NEGRO	CLASSIC 2	12	2
110-111	349.46.J	ROLL SILLA	HUSK 0734	138-ALPINO	HUSK FEBRIK KVADRAT	8	1



# **SANCAL** REF. 20003\_MUSEO\_COLLECTION

SANCAL DISEÑO, S.L.  
Pol. Ind. La Herrada C/ Príncipe de Asturias, 18  
30510 Yecla (Murcia) Spain  
Tel Esp. +34 968 75 15 03  
Tel. Eng. +34 968 71 90 62  
Tel. Fra. +34 968 71 90 61  
Fax +34 968 79 40 62  
e-mail [web@sancal.com](mailto:web@sancal.com)  
[www.sancal.com](http://www.sancal.com)

Art direction & styling  
Juan Ibáñez, Elena Castaño-López & Carolina Mico  
Photography Marcelo Martínez  
Coordination Esther Castaño-López  
Graphic project Juan Ibáñez

Copyright © Sancal Diseño S.L. 2020



Nº depósito legal MU 816-202

Print xxxx



